

20. септембар 2019

Научно веће Института за физику

Предмет: Молба за избор у звање истраживач сарадник

Поштовани,

С обзиром да испуњавам критеријуме прописане од стране Министарства просвете, науке и технолошког развоја Републике Србије, молим Научно веће Института за физику у Земуну да покрене поступак за мој избор у звање Истраживач сарадник.

У прилогу достављам:

- Мишљење руководиоца пројекта;
- Стручну биографију;
- Преглед научне активности;
- Списак и копије одабранх радова;
- Нострификовану диплому са докторских студија

С поштовањем,

др Ларс Бемстер

20. септембар 2019

Научно веће Института за физику

Предмет: Мишљење руководиоца пројекта за избор др Ларса Бемстера (Lars Beemster) у звање истраживач сарадник

Поштовани,

Др Ларс Бемстер докторирао је на Универзитету Твентеа и институту НИКНЕФ у Холандији радећи на експерименту АТЛАС. Ми планирамо да га укључимо на пројекат основних истраживања Министарства просвете, науке и технолошког развоја 171004 под називом “АТЛАС експеримент и физика честица на ЛХЦ енергијама”. Био би ангажован у развоју тригера за експеримент, а такође би обезбеђивао софтверску подршку и укључио би се у анализу података.

С обзиром да др Ларс Бемстер испуњава све услове предвиђене Правилником о поступку и начину вредновања, и квантитативном исказивању научноистраживачких резултата истраживача, сагласна сам са покретањем поступка за избор у звање истраживач сарадник.

За чланове комисије за избор др Ларса Бемстера у звање истраживач сарадник предлажем следећи састав:

1. др Лидија Живковић, научни саветник, Институт за физику;
2. др Ненад Врањеш, виши научни сарадник, Институт за физику;
3. проф. др Предраг Миленовић, ванредни професор Физичког факултета;

Руководилац пројекта 171004,



др Лидија Живковић
Научни саветник

Биографски подаци

Др Ларс Бемстер рођен је у Варланду, Холандија, 11. јула 1983. године, где је завршио основну и средњу школу. Академску каријеру започео је 2005 на Универзитету Твентеа у Холандији, где је уписао основне студије. По завршетку основних студија, 2008. године (просек оцена 8.55), уписује мастер студије на смеру Физика честица и Астрофизика на холандском националном институту за физику високих енергија, NIKHEF, у Амстердаму. Исте године био је изабран да учествује у Церновој летњој школи, где је провео 3 месеца. Током летњег програма учествовао је на пројекту HiSPARC. Мастер пројекат урадио је под руководством проф. др Боба ван Еијка на пројекту ANTARES, а тема је “Multi-messenger correlation studies: the ANTARES neutrino telescope and the Pierre Auger Ultra High Energy Cosmic Ray Observatory”. Резултати истраживања објављени су у часопису *Astrophysics Journal*, а теза је одбрањена 2010 са почастима. Исте године започео је докторске студије на Универзитету Твентеа под такође менторством проф. др Боба ван Еијка на експерименту АТЛАС у Церну. Радио је на појекту унапређења сузбијања шума при реконструкцији џетова који се користе у систему тригера. Такође је био експерт за квалитет података и дебаговање тригера. Испитвао је и утцај догађаја пара векторских бозона у процесу двоструке интеракције партона на студије Хигсовог бозона и структуре протона. Током студија учествовао је у промоцији науке на Универзитету у Твентеу. По завршетку докторских студија радио је у финансијској корпорацији Solid FX као аналитичар, где је примењивао знање стечено током студија на испитивање тржишта девиза. У том периоду остао је у контакту са колегама са Универзитета у Твентеу доринисећи развоју програма за обраду података ROOT.

Преглед научне активности

Током мастер студија, др Ларс Бемстер је изучавао космичко зрачење у оквиру групе за Астрофизику. На пројекту HiSPARC током летње школе, направио је симулацију детектора космичког зрачења који се користио у експерименту. За мастер студије придружио се експерименту ANTARES. Истраживао је корелације између космичких зрака ултра високих енергија и космичких неутрина који су детектовани на истом експерименту. Ко-аутор је на публикацији која сумира резултате овог истраживања:

- S. Adrian-Martinez, ..., L. J. Beemster, et al., “Search for a correlation between ANTARES neutrinos and Pierre Auger Observatory UHECRs arrival directions”, *ApJ*, 2013, 774, 19

а његов рад описан је у интерној noti колаборације:

- J Petrovic, L.J. Beemster, “MMP – a software package for multi-messenger data analysis”, Antares internal note 2011

За своје докторске студије на експерименту АТЛАС, кандидат је радио на унапређењу тригера на вишем, софтверском нивоу (HLT - High Level Trigger). Развио је нови алгоритам који је побољшао смањивање шума џетова који се користе за тригере. Овај алгоритам, који је имплементиран у мени тригера, описан је у интерној noti колаборације АТЛАС и резултати су искоришћени у публикацији:

- Beemster L. (editor), Begel M., Campanelli M., Chapleau B., Igonkina O., “Jet cleaning in the HLT”, ATLAS internal note, ATL-COM-DAQ-2013-036
- ATLAS Collaboration, “Performance of the ATLAS Trigger System in 2015”, *Eur. Phys. J. C* 77 (2017) 317

Такође је испитивао могућност производње пара векторских бозона у процесу двоструке интеракције партона (DPI – double parton interaction) у оквиру групе за Електрослабе интеракције. Та веома захтевна анализа била је и део студије позадинских процеса потраге за Хигсовим бозоном. Кандидат је помоћу Монте Карло симулације генерисао познате електрослабе процесе и користио експерименталне методе да из реалних података опише процесе које је тешко прецизно симулирати, као на пример $W + \text{jets}$ догађаје. Потом је применио модерне методе машинског учења на ове узорке

како би их разликовао. Закључак ове анализе користећи DPI догађаје симулиране помоћу генератора Pythia био је да је допринос овог процеса у сигналном региону процеса $H \rightarrow WW$ занемарљив. Такође је показано како продукција парова W бозона у DPI може да се користи у испитивању структуре протона, али да је количина података прикупљених 2012 недовољна да би ова анализа довела до значајних резултата. Истраживање ових процеса биће значајније како расте енергија снопова код сударача.

Списак публикација

Рад у врхунском међународном часопису (M21)

1. S. Adrian-Martinez, ..., L. J. Beemster, et al., “Search for a correlation between ANTARES neutrinos and Pierre Auger Observatory UHECRs arrival directions”, *ApJ*, 2013, 774, 19
2. ATLAS Collaboration, “Performance of the ATLAS Trigger System in 2015”, *Eur. Phys. J. C* 77 (2017) 317

Одбрањена докторска дисертација (M70)

1. Lars Beemster, “Same sign W pair production in double parton interactions”



Република Србија
Агенција за квалификације

Број: 612-01-03-83/2019

Датум: 06.08.2019. године

Мајке Јевросиме 51

Београд

јк

На основу члана 38, члана 20. став 1. тачка 7 и члана 5. став 1. Тачка 10. Закона о националном оквиру квалификација Републике Србије („Сл. гласник РС”, бр. 27/18), члана 131. став 1. Закона о високом образовању („Сл. гласник РС”, бр. 88/17, 27/18 – др. закон и 73/18), и члана 136. став 1. Закона о општем управном поступку („Службени гласник РС”, бр. 18/16 и 95/18 – аутентично тумачење), решавајући по захтеву Лауренциуса Јакобуса Бемстера из Панчева, Република Србија, за признавање високошколске исправе издате у Краљевини Холандији, ради запошљавања,
директор Агенције за квалификације доноси

РЕШЕЊЕ

1. Диплома издата у јануару 2017. године од стране Универзитета Твенте (University of Twente), Еншеде, Краљевина Холандија, на име Laurentius Jacobus Beemster, рођен 11.07.1983. године у Ваарланду, Краљевина Холандија, о завршеним докторским академским студијама високог образовања у четворогодишњем трајању, студијски програм: Астрономија, дисертација: “Исти знак W стварања парова у интеракцији двоструких партона”, звање/квалификација: Doctor / Доктор, Доктор наука – астрономске науке (на основу превода овлашћеног судског тумача за енглески језик), **признаје се** као диплома докторских академских студија трећег степена високог образовања (180 ЕСПБ), у оквиру образовно-научног поља: Природно-математичке науке, научна односно стручна област: Математичке науке, која одговара нивоу 8 НОКС-а, ради запошљавања.
2. Ово решење омогућава имаоцу општи приступ тржишту рада у Републици Србији, али га не ослобађа од испуњавања посебних услова за бављење професијама које су регулисане законом или другим прописом.
3. Превод звања/квалификације из тачке 1. диспозитива овог решења које је са оригиналне стране јавне исправе превео овлашћени судски тумач за енглески језик, не представља стручни, академски, научни односно уметнички назив који у складу са чланом 12. ставом 1. тачка 9. Закона о високом образовању, утврђује Национални савет за високо образовање.

Образложење

Агенцији за квалификације обратио се Лауренциус Јакобус Бемстер из Панчева, Република Србија, захтевом од 27.05.2019. године за признавање дипломе Универзитета Твенте (University of Twente), Еншеде, Краљевина Холандија, докторске академске студије високог образовања, студијски програм: Астрономија, дисертација: “Исти знак W стварања парова у интеракцији двоструких партона”, звање/квалификација: Doctor / Доктор, Доктор наука – астрономске науке, ради запошљавања.

Уз захтев, подносилац захтева доставио је:

- 1) оверену копију дипломе издату у јануару 2017. године од стране Универзитета Твенте (University of Twente), Еншеде, Краљевина Холандија, студијски програм: Астрономија, звање/квалификација: Doctor;
- 2) оверени превод дипломе на српски језик;
- 3) примерак дисертације на изворном језику;
- 4) апстракт рада на енглеском језику;
- 5) листу објављених радова;
- 6) радну биографију;
- 7) оверене копије претходно стечених квалификација са документацијом;
- 8) пријавни формулар;
- 9) доказ о уплати таксе за професионално признавање.

Одредбом члана 136. став 1. Закона о општем управном поступку прописано је да се решењем одлучује о праву, обавези или правном интересу странке.

Одредбом члана 38. став 1. Закона о националном оквиру квалификација Републике Србије прописано је да захтев за професионално признавање заинтересовано лице подноси Агенцији. Ставом 2. наведеног члана прописано је да професионално признавање врши ENIC/NARIC центар, као организациони део Агенције, по претходно извршеном вредновању страног студијског програма, у складу са овим и законом који уређује високо образовање. Ставом 3. наведеног члана прописано је да решење о професионалном признавању посебно садржи: назив, врсту, степен и трајање (обим) студијског програма, односно квалификације, који је наведен у страног високошколској исправи – на изворном језику и у преводу на српски језик и научну, уметничку, односно стручну област у оквиру које је остварен студијски програм, односно врсту и ниво квалификације у Републици и ниво НОКС-а којем квалификација одговара. Ставом 4. наведеног члана прописано је да директор агенције доноси решење о професионалном признавању у року од 90 дана од дана пријема уредног захтева. Ставом 5. наведеног члана прописано је да решење из става 4. овог члана не ослобађа имаоца од испуњавања посебних услова за обављање одређене професије прописане посебним законом. Ставом 6. наведеног члана прописано је да је решење о професионалном признавању коначно. Ставом 7. наведеног члана прописано је да уколико није другачије прописано, на поступак професионалног признавања примењује се закон којим се уређује општи управни поступак. Ставом 8. наведеног члана прописано је да решење о професионалном признавању има значај јавне исправе. Ставом 9. наведеног члана прописано је да ближе услове у погледу поступка професионалног признавања прописује министар надлежан за послове образовања.

Одредбом члана 20. став 1. тачка 7. Закона о националном оквиру квалификација Републике Србије, директор Агенције за потребе давања стручног мишљења у поступку вредновања страног студијског програма именује комисију од најмање три рецензента са листе рецензената коју утврђује Национални савет за високо образовање, у складу са законом који уређује високо образовање и овим законом.

Одредбом члана 131. став 1. Закона о високом образовању, прописано је да се вредновање страног студијског програма врши на основу врсте и нивоа постигнутих компетенција стечених завршетком студијског програма, узимајући у обзир систем образовања у земљи у којој је високошколска исправа стечена, услове уписа, права која проистичу из стране високошколске исправе у земљи у којој је стечена и друге релевантне чињенице, без разматрања формалних обележја и структуре студијског програма.

Одредбом члана 5. став 1. тачка 10. Закона о националном оквиру квалификација Републике Србије, прописано је да се осми ниво стиче завршавањем докторских студија обима 180 ЕСПБ бодова (уз претходно завршене интегрисане академске, односно мастер академске студије).

Одлучујући о захтеву подносиоца, а након прибављеног мишљења комисије која је извршила вредновање страног студијског програма на основу врсте и нивоа постигнутих компетенција стечених завршетком студијског програма, узимајући у обзир систем образовања у земљи у којој је високошколска исправа стечена, услове уписа, права која проистичу из стране високошколске исправе у земљи у којој је стечена и друге релевантне чињенице, без разматрања формалних обележја и структуре студијског програма, одлучено је да се диплома Универзитета Твенте (University of Twente), Еншеде, Краљевина Холандија, може признати као

диплома докторских студија трећег степена високог образовања (180 ЕСПБ), која одговара нивоу 8. НОКС-а.

Са напред наведених разлога директор Агенције је нашао да су у конкретном случају испуњени претходно наведени сви законом прописани услови да се призна диплома Универзитета Твенте (University of Twente), Еншеде, Краљевина Холандија, као диплома докторских академских студија трећег степена високог образовања (180 ЕСПБ), у оквиру образовно-научног поља: Природно-математичке науке, научна односно стручна област: Математичке науке, која одговара нивоу 8 НОКС-а, ради запошљавања.

Такса за решење по захтеву, по тарифном броју 172. тачка 3, подтачка 4а) Закона о републичким административним таксама ("Службени гласник РС", бр. 43/03, 51/03-испр., 61/05, 101/05-др.закон, 5/09, 54/09, 50/11, 70/11- усклађени дин.изн., 55/12- усклађени дин.изн., 93/12, 47/13 - усклађени дин.изн, 65/13-др.закон, 57/14- усклађени дин.изн, 45/15- усклађени дин.изн, 83/15, 112/15, 50/16- усклађени дин.изн., 61/17- усклађени дин.изн., 113/17, 3/18, 50/18 и 95/18), плаћена је и поништена.

Сходно претходно наведеном, донета је одлука као у диспозитиву решења.

Упутство о правном средству: Ово решење је коначно у управном поступку и против истог може се покренути управни спор. Тужба се подноси Управном суду у року од 30 дана од дана пријема овог решења.

Решење доставити:

- Лауренциус Јакобус Бемстер, ул. Дунавска бр. 8/4, 26000 Панчево;
- Архиви.



ДИРЕКТОР

проф. др Часлав Митровић

THE DOCTORATE BOARD OF THE
UNIVERSITY OF TWENTE BY VIRTUE
OF ITS AUTHORITY UNDER THE DUTCH
LAW ADMITS

LAURENTIUS JACOBUS BEEMSTER

BORN ON JULI 11TH, 1983 IN WAARLAND, THE NETHERLANDS

TO THE DEGREE OF DOCTOR,
(PURSUANT TO "DE WET OP HET HOGER ONDERWIJS EN WETENSCHAPPELIJK
ONDERZOEK" (THE LAW ON HIGHER EDUCATION AND SCIENTIFIC RESEARCH),
ARTICLES 7.18 AND 7.22)

HAVING HEARD THE DEFENCE ON JANUARY 11TH, 2017 OF THE THESIS
ENTITLED:

SAME SIGN W PAIR PRODUCTION IN DOUBLE PARTON INTERACTIONS

CHAIRMAN OF THE DOCTORATE BOARD



PROF.DR. T.T.M. PALSTRA

ENSCHDE, JANUARY 2017

TRANSLATION OF THE DOCTORAL DIPLOMA

UNIVERSITY OF TWENTE.

0025453

GETUIGSCHRIFT

ACADEMISCH ONDERWIJS

De examencommissie van de bacheloropleiding

Technische Natuurkunde

aan de Faculteit Technische Natuurwetenschappen van de Universiteit Twente te Enschede,
verklaart dat

- LAURENTIUS JACOBUS BEEMSTER -

geboren op 11 JULI 1983 te HARENKARPEL

het afsluitend examen van de opleiding met goed gevolg heeft afgelegd en daarmee bij wet
recht heeft op de graad

Bachelor of Science

Enschede, 24 JUNI 2009

De geëxamineerde

De examencommissie



UNIVERSITEIT TWENTE

Dit getuigschrift vormt één geheel met het diplomasupplement
NVAO geaccrediteerd op 20-06-2008



TRUE AND CERTIFIED COPY
True and certified copy of original document
University of Twente Student Services

Paraph: 

Date: 27-03-19

DIPLOMA

ACADEMIC EDUCATION

The examination board for the master's degree programme in

Applied Physics

at the Faculty of **Science and Technology** of the University of Twente in Enschede,
The Netherlands, declares that

- Laurentius J. Beemster -

born July 11, 1983 in Harenkarspel, The Netherlands

has passed the final examination of this programme and is thus entitled to the degree

Master of Science

- Cum Laude -



TRUE AND CERTIFIED COPY
True and certified copy of original document
University of Twente, Student Services

Paraph: 

Date: 27-03-10

Enschede, October 20, 2010

The Examinee

The Examination Board



A diploma supplement is issued with this diploma
NVAO accreditation: December 9, 2008

UNIVERSITY OF TWENTE.

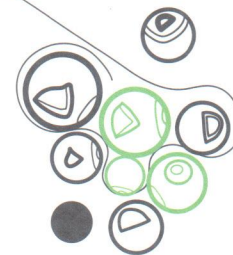

L.J. Beemster
Schaapskuilweg 5
1738 DS WAARLAND

Subject: File overview - 0025453
Date: 27-03-2019 10:42

Degree programme	Degree	Full time/part time	Degrees	Specialization
Bachelor Advanced Technology	P	F		
Bachelor Applied Physics	B	F	P 20-06-2006 Graduated B 24-06-2009 Graduated	
Bachelor Computer Science & Engineering	P	F		
Computer Science	PO	F		
Master Applied Physics	-	F	M 20-10-2010 Cum Laude	

Grades Bachelor Propedeuse

European Credits

Course	Name	Date	Grade	Credits
191300041	Structure and Reactivity	20-06-2006	HNTD	
191300070	Project Material Science	20-06-2006	HNTD	
191375141	Process Technology	20-06-2006	HNTD	
191399170	Experimenting Chemical Engineering	20-06-2006	HNTD	
191403001	Orientation in Science and Technology	30-05-2005	VR	5.0
191403011	Energy and Entropy	08-11-2005	6	5.0
191403021	Dynamics	31-08-2005	7	5.0
191403033	Dynamic Modelation and Simulation	20-06-2006	7	5.0
191403041	Projects First Year	21-06-2005	8	5.0
191403051	Electromagnetics	22-08-2005	6	5.0
191405801	Experiments in Science I	14-01-2005	7	5.0
191405811	Experiments in Science II	22-03-2005	7	5.0
191405820	Instrumentation	26-05-2005	8	5.0
191511200	Mathematics I	14-08-2002	6	4.3
191520680	Discrete mathematics	20-03-2003	3	
191521000	Calculus I	06-06-2005	VR	5.0
191521100	Calculus II	08-04-2005	8	5.0
191521200	Linear Algebra	31-08-2005	9	5.0
191841720	Human Resource, Technology & Organization	19-03-2003	O	
192111801	Basic Models in Computer Science	01-07-2002	2	
192120100	Information Systems	19-08-2003	3	
192145000	Communication and Design in ICT-projects	07-12-2001	7	2.9
192145010	Communication and Design in ICT-projects	18-02-2002	7	2.9
192350040	Introduction to business information tec	19-03-2003	HNTD	
Total				70.1

L.J. Beemster (0025453)

UNIVERSITY OF TWENTE.



1/3

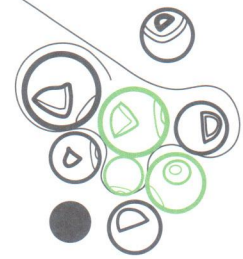

Grades Bachelor Main Phase

European Credits

Course	Name	Date	Grade	Credits
191407023	Optics Laboratory	27-02-2006	7	2.5
191407051	Introduction to Instrumentation Computer	20-04-2007	8	2.5
191407080	Computational Physics	04-07-2006	8	2.5
191410010	Quantum Phenomena	03-11-2005	8	5.0
191410020	Thermodynamics and Statistical Physics	24-06-2009	8	5.0
191411272	Classical Mechanics	22-01-2009	7	5.0
191411281	Introduction Quantummechanics	29-06-2006	7	5.0
191420021	Introduction to Solid State Physics	27-03-2007	7	7.5
191420131	Materials Science	27-06-2008	8	5.0
191440063	Electrodynamics	06-11-2006	8	5.0
191441182	Physical Signal Analyses and Processing	10-04-2007	6	5.0
191460121	Introduction to Optics	30-08-2006	6	5.0
191470231	Physics of Fluids	30-08-2007	8	5.0
191470251	Physics of Fluids Practical	17-04-2008	7	2.5
191499879	Bachelor Assignment	02-07-2007	7	10.0
191511240	Linear Analysis	01-02-2006	7	5.0
191540262	Algorithms and Programming	15-02-2006	10	2.5
191560130	Differential Equations	25-08-2006	7	5.0
191560810	Signals and Transformations	23-01-2006	6	5.0
191623300	Technology Assessment of ICT	14-05-2003	6	4.3
192130050	Computer Architecture	14-03-2003	7	4.3
192131001	Digital design	11-03-2002	6	4.3
192135000	Programming 1	12-03-2002	6	4.3
192135050	Programming 2	29-08-2002	6	4.3
192145100	MMI-project	25-06-2002	7	7.1
192145110	Database Project	02-12-2002	7	2.9
192145120	Computer Architectureproject	07-03-2003	V	2.9
192145130	Internet & Web Architecture	27-06-2003	7	2.9
192145150	Codesign Project	25-07-2003	6	4.3
192610000	Telematics Systems and Applications	28-11-2001	7	4.3
193530040	Introduction to HEF	01-06-2007	8	5.0
Total				140.9

L.J. Beemster (0025453)

UNIVERSITY OF TWENTE.



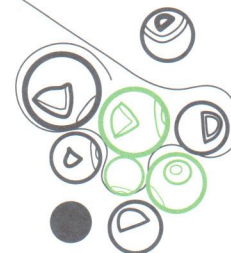

Grades Master

European Credits

Course	Name	Date	Grade	Credits
191411291	Applied Quantum Mechanics	13-04-2007	4	
192135100	Software Engineering Models	23-02-2003	4	
193599010	Internship	19-08-2010	8	20.0
193599039	Master Thesis: Physical Aspects	20-10-2010	9	25.0
193599089	Master Thesis: General Aspects	20-10-2010	9	25.0
193599301	Course other University	18-12-2007	8	6.0
193599302	Course other University	25-06-2008	9	3.0
193599303	Course other University	31-01-2008	9	6.0
193599304	Course other University	25-06-2008	9	6.0
193599305	Course other University	03-06-2009	9	6.0
193599306		20-12-2007	7	6.0
193599307	Course other University	28-07-2009	8	3.0
193599308	Course other University	23-06-2008	8	6.0
200900059	Capita Selecta EMS	12-07-2010	V	6.0
Total				118.0

Courses at another institution

Course	Name	Date	Degree	Grade	Credits
X-420014	Course other University	12-07-2010	M	8	6.0

L.J. Beemster (0025453)

UNIVERSITY OF TWENTE.



3/3

Performance of the ATLAS trigger system in 2015

ATLAS Collaboration*

CERN, 1211 Geneva 23, Switzerland

Received: 30 November 2016 / Accepted: 23 April 2017 / Published online: 18 May 2017
© CERN for the benefit of the ATLAS collaboration 2017. This article is an open access publication

Abstract During 2015 the ATLAS experiment recorded 3.8 fb^{-1} of proton–proton collision data at a centre-of-mass energy of 13 TeV. The ATLAS trigger system is a crucial component of the experiment, responsible for selecting events of interest at a recording rate of approximately 1 kHz from up to 40 MHz of collisions. This paper presents a short overview of the changes to the trigger and data acquisition systems during the first long shutdown of the LHC and shows the performance of the trigger system and its components based on the 2015 proton–proton collision data.

Contents

1	Introduction	2
2	ATLAS detector	2
3	Changes to the Trigger/DAQ system for Run 2	3
3.1	Level-1 calorimeter trigger	4
3.2	Level-1 muon trigger	5
4	Trigger menu	6
4.1	Physics trigger menu for 2015 data-taking	7
4.2	Event streaming	8
4.3	HLT processing time	9
4.4	Trigger menu for special data-taking conditions	9
5	High-level trigger reconstruction	10
5.1	Inner detector tracking	11
5.1.1	Inner detector tracking algorithms	11
5.1.2	Inner detector tracking performance	11
5.1.3	Multiple stage tracking	11
5.1.4	Inner detector tracking timing	14
5.2	Calorimeter reconstruction	14
5.2.1	Calorimeter algorithms	14
5.2.2	Calorimeter algorithm performance	15
5.2.3	Calorimeter algorithm timing	16
5.3	Tracking in the muon spectrometer	16
5.3.1	Muon tracking algorithms	16
5.3.2	Muon tracking performance	17
5.3.3	Muon tracking timing	17

6	Trigger signature performance	18
6.1	Minimum-bias and forward triggers	18
6.1.1	Reconstruction and selection	18
6.1.2	Trigger efficiencies	19
6.2	Electrons and photons	20
6.2.1	Electron and photon reconstruction and selection	20
6.2.2	Electron and photon trigger menu and rates	21
6.2.3	Electron and photon trigger efficiencies	21
6.3	Muons	22
6.3.1	Muon reconstruction and selection	23
6.3.2	Muon trigger menu and rates	23
6.3.3	Muon trigger efficiencies	23
6.4	Jets	24
6.4.1	Jet reconstruction	25
6.4.2	Jet trigger menu and rates	25
6.4.3	Jet trigger efficiencies	25
6.4.4	Jets and trigger-level analysis	27
6.5	Tau leptons	27
6.5.1	Tau reconstruction and selection	28
6.5.2	Tau trigger menu and rates	28
6.5.3	Tau trigger efficiencies	28
6.6	Missing transverse momentum	29
6.6.1	E_T^{miss} reconstruction and selection	29
6.6.2	E_T^{miss} trigger menu and rates	32
6.6.3	E_T^{miss} trigger efficiencies	32
6.7	b -Jets	34
6.7.1	b -Jet reconstruction and selection	35
6.7.2	b -Jet trigger menu and rates	36
6.8	B -physics	37
6.8.1	B -physics reconstruction and selection	37
6.8.2	B -physics trigger menu and rates	37
6.8.3	B -physics trigger efficiencies	38
7	Conclusion	38
	References	39

* e-mail: atlas.publications@cern.ch

1 Introduction

The trigger system is an essential component of any collider experiment as it is responsible for deciding whether or not to keep an event from a given bunch-crossing interaction for later study. During Run 1 (2009 to early 2013) of the Large Hadron Collider (LHC), the trigger system [1–5] of the ATLAS experiment [6] operated efficiently at instantaneous luminosities of up to $8 \times 10^{33} \text{ cm}^{-2} \text{ s}^{-1}$ and primarily at centre-of-mass energies, \sqrt{s} , of 7 TeV and 8 TeV. In Run 2 (since 2015) the increased centre-of-mass energy of 13 TeV, higher luminosity and increased number of proton–proton interactions per bunch-crossing (pile-up) meant that, without upgrades of the trigger system, the trigger rates would have exceeded the maximum allowed rates when running with the trigger thresholds needed to satisfy the physics programme of the experiment. For this reason, the first long shutdown (LS1) between LHC Run 1 and Run 2 operations was used to improve the trigger system with almost no component left untouched.

After a brief introduction of the ATLAS detector in Sect. 2, Sect. 3 summarises the changes to the trigger and data acquisition during LS1. Section 4 gives an overview of the trigger menu used during 2015 followed by an introduction to the reconstruction algorithms used at the high-level trigger in Sect. 5. The performance of the different trigger signatures is shown in Sect. 6 for the data taken with 25 ns bunch-spacing in 2015 at a peak luminosity of $5 \times 10^{33} \text{ cm}^{-2} \text{ s}^{-1}$ with comparison to Monte Carlo (MC) simulation.

2 ATLAS detector

ATLAS is a general-purpose detector with a forward-backward symmetry, which provides almost full solid angle coverage around the interaction point.¹ The main components of ATLAS are an inner detector (ID), which is surrounded by a superconducting solenoid providing a 2T axial magnetic field, a calorimeter system, and a muon spectrometer (MS) in a magnetic field generated by three large superconducting toroids with eight coils each. The ID provides track reconstruction within $|\eta| < 2.5$, employing a pixel detector (Pixel) close to the beam pipe, a silicon microstrip detector (SCT) at intermediate radii, and a transition radiation tracker (TRT) at outer radii. A new innermost pixel-detector layer, the insertable B-layer (IBL), was added dur-

ing LS1 at a radius of 33 mm around a new and thinner beam pipe [7]. The calorimeter system covers the region $|\eta| < 4.9$, the forward region ($3.2 < |\eta| < 4.9$) being instrumented with a liquid-argon (LAr) calorimeter for electromagnetic and hadronic measurements. In the central region, a lead/LAr electromagnetic calorimeter covers $|\eta| < 3.2$, while the hadronic calorimeter uses two different detector technologies, with steel/scintillator tiles ($|\eta| < 1.7$) or lead/LAr ($1.5 < |\eta| < 3.2$) as absorber/active material. The MS consists of one barrel ($|\eta| < 1.05$) and two end-cap sections ($1.05 < |\eta| < 2.7$). Resistive plate chambers (RPC, three doublet layers for $|\eta| < 1.05$) and thin gap chambers (TGC, one triplet layer followed by two doublets for $1.0 < |\eta| < 2.4$) provide triggering capability as well as (η, ϕ) position measurements. A precise momentum measurement for muons with $|\eta|$ up to 2.7 is provided by three layers of monitored drift tubes (MDT), with each chamber providing six to eight η measurements along the muon trajectory. For $|\eta| > 2$, the inner layer is instrumented with cathode strip chambers (CSC), consisting of four sensitive layers each, instead of MDTs.

The Trigger and Data Acquisition (TDAQ) system shown in Fig. 1 consists of a hardware-based first-level trigger (L1) and a software-based high-level trigger (HLT). The L1 trigger decision is formed by the Central Trigger Processor (CTP), which receives inputs from the L1 calorimeter (L1Calo) and L1 muon (L1Muon) triggers as well as several other subsystems such as the Minimum Bias Trigger Scintillators (MBTS), the LUCID Cherenkov counter and the Zero-Degree Calorimeter (ZDC). The CTP is also responsible for applying preventive dead-time. It limits the minimum time between two consecutive L1 accepts (*simple dead-time*) to avoid overlapping readout windows, and restricts the number of L1 accepts allowed in a given number of bunch-crossings (*complex dead-time*) to avoid front-end buffers from overflowing. In 2015 running, the simple dead-time was set to 4 bunch-crossings (100 ns). A more detailed description of the L1 trigger system can be found in Ref. [1]. After the L1 trigger acceptance, the events are buffered in the Read-Out System (ROS) and processed by the HLT. The HLT receives Region-of-Interest (RoI) information from L1, which can be used for regional reconstruction in the trigger algorithms. After the events are accepted by the HLT, they are transferred to local storage at the experimental site and exported to the Tier-0 facility at CERN's computing centre for offline reconstruction.

Several Monte Carlo simulated datasets were used to assess the performance of the trigger. Fully simulated photon+jet and dijet events generated with PYTHIA8 [8] using the NNPDF2.3LO [9] parton distribution function (PDF) set were used to study the photon and jet triggers. To study tau and *b*-jet triggers, $Z \rightarrow \tau\tau$ and $t\bar{t}$ samples generated with POWHEG-BOX 2.0 [10–12] with the CT10 [13] PDF

¹ ATLAS uses a right-handed coordinate system with its origin at the nominal interaction point (IP) in the centre of the detector and the z -axis along the beam pipe. The x -axis points from the IP to the centre of the LHC ring, and the y -axis points upward. Cylindrical coordinates (r, ϕ) are used in the transverse plane, ϕ being the azimuthal angle around the z -axis. The pseudorapidity is defined in terms of the polar angle θ as $\eta = -\ln \tan(\theta/2)$.

Fig. 1 The ATLAS TDAQ system in Run 2 with emphasis on the components relevant for triggering. L1Topo and FTK were being commissioned during 2015 and not used for the results shown here

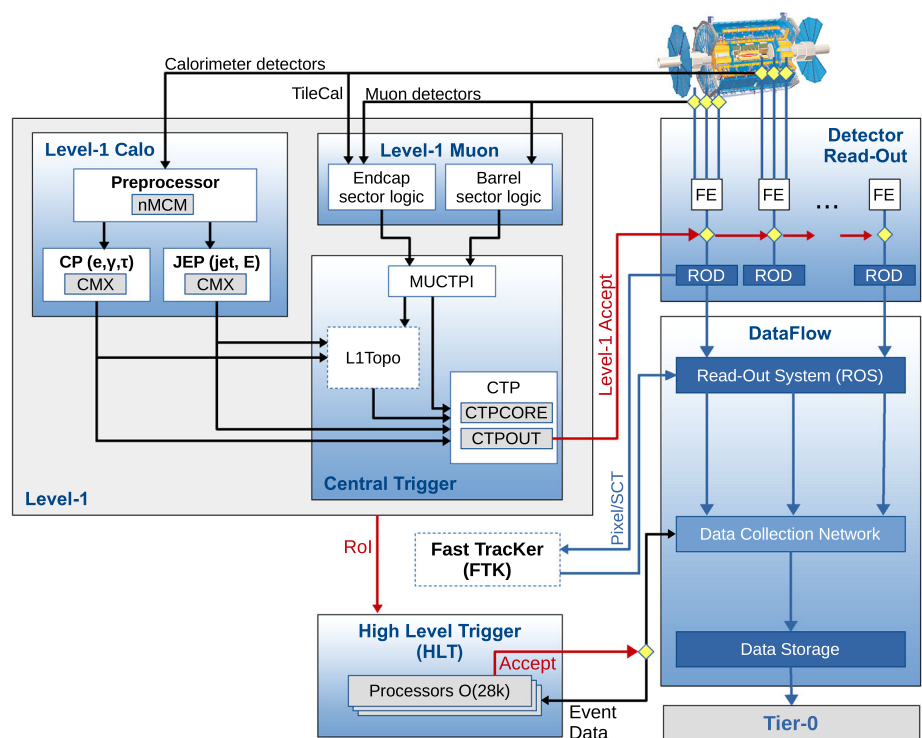

set and interfaced to PYTHIA8 or PYTHIA6 [14] with the CTEQ6L1 [15] PDF set were used.

3 Changes to the Trigger/DAQ system for Run 2

The TDAQ system used during Run 1 is described in detail in Refs. [1, 16]. Compared to Run 1, the LHC has increased its centre-of-mass energy from 8 to 13 TeV, and the nominal bunch-spacing has decreased from 50 to 25 ns. Due to the larger transverse beam size at the interaction point ($\beta^* = 80$ cm compared to 60 cm in 2012) and a lower bunch population (1.15×10^{11} instead of 1.6×10^{11} protons per bunch) the peak luminosity reached in 2015 ($5.0 \times 10^{33} \text{ cm}^{-2} \text{ s}^{-1}$) was lower than in Run 1 ($7.7 \times 10^{33} \text{ cm}^{-2} \text{ s}^{-1}$). However, due to the increase in energy, trigger rates are on average 2.0 to 2.5 times larger for the same luminosity and with the same trigger criteria (individual trigger rates, e.g. jets, can have even larger increases). The decrease in bunch-spacing also increases certain trigger rates (e.g. muons) due to additional interactions from neighbouring bunch-crossings (out-of-time pile-up). In order to prepare for the expected higher rates in Run 2, several upgrades and additions were implemented during LS1. The main changes relevant to the trigger system are briefly described below.

In the L1 Central Trigger, a new topological trigger (L1Topo) consisting of two FPGA-based (Field-Programmable Gate Arrays) processor modules was added. The modules are identical hardware-wise and each is pro-

grammed to perform selections based on geometric or kinematic association between trigger objects received from the L1Calo or L1Muon systems. This includes the refined calculation of global event quantities such as missing transverse momentum (with magnitude E_T^{miss}). The system was fully installed and commissioned during 2016, i.e. it was not used for the data described in this paper. Details of the hardware implementation can be found in Ref. [17]. The Muon-to-CTP interface (MUCTPI) and the CTP were upgraded to provide inputs to and receive inputs from L1Topo, respectively. In order to better address sub-detector specific requirements, the CTP now supports up to four independent complex dead-time settings operating simultaneously. In addition, the number of L1 trigger selections (512) and bunch-group selections (16), defined later, were doubled compared to Run 1. The changes to the L1Calo and L1Muon trigger systems are described in separate sections below.

In Run 1 the HLT consisted of separate Level-2 (L2) and Event Filter (EF) farms. While L2 requested partial event data over the network, the EF operated on full event information assembled by separate farm nodes dedicated to Event Building (EB). For Run 2, the L2 and EF farms were merged into a single homogeneous farm allowing better resource sharing and an overall simplification of both the hardware and software. RoI-based reconstruction continues to be employed by time-critical algorithms. The functionality of the EB nodes was also integrated into the HLT farm. To achieve higher readout and output rates, the ROS, the data collection network and data storage system were upgraded. The

on-detector front-end (FE) electronics and detector-specific readout drivers (ROD) were not changed in any significant way.

A new Fast TracKer (FTK) system [18] will provide global ID track reconstruction at the L1 trigger rate using lookup tables stored in custom associative memory chips for the pattern recognition. Instead of a computationally intensive helix fit, the FPGA-based track fitter performs a fast linear fit and the tracks are made available to the HLT. This system will allow the use of tracks at much higher event rates in the HLT than is currently affordable using CPU systems. This system is currently being installed and expected to be fully commissioned during 2017.

3.1 Level-1 calorimeter trigger

The details of the L1Calo trigger algorithms can be found in Ref. [19], and only the basic elements are described here. The electron/photon and tau trigger algorithm (Fig. 2) identifies an RoI as a 2×2 trigger tower cluster in the electromagnetic calorimeter for which the sum of the transverse energy from at least one of the four possible pairs of nearest neighbour towers (1×2 or 2×1) exceeds a predefined threshold. Isolation-veto thresholds can be set for the electromagnetic (EM) isolation ring in the electromagnetic calorimeter, as well as for hadronic tower sums in a central 2×2 core behind the EM cluster and in the 12-tower hadronic ring around it.

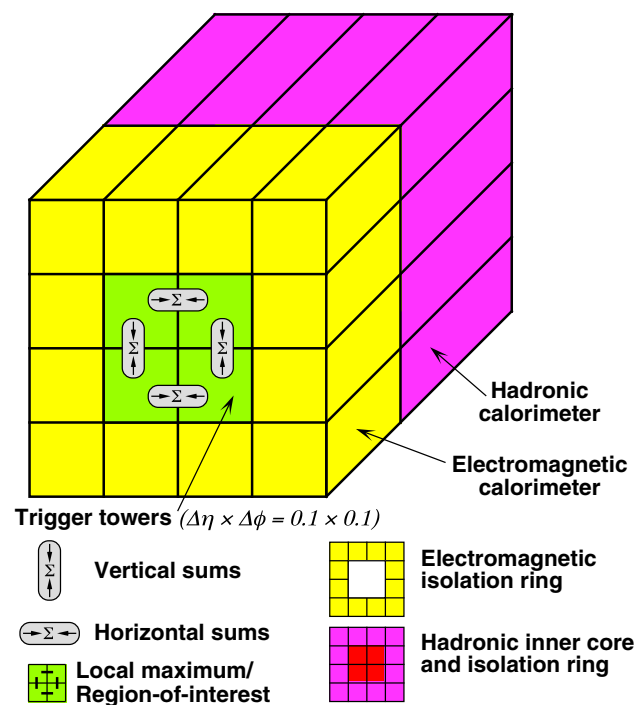

Fig. 2 Schematic view of the trigger towers used as input to the L1Calo trigger algorithms

The E_T threshold can be set differently for different η regions at a granularity of 0.1 in η in order to correct for varying detector energy responses. The energy of the trigger towers is calibrated at the electromagnetic energy scale (EM scale). The EM scale correctly reconstructs the energy deposited by particles in an electromagnetic shower in the calorimeter but underestimates the energy deposited by hadrons. Jet RoIs are defined as 4×4 or 8×8 trigger tower windows for which the summed electromagnetic and hadronic transverse energy exceeds predefined thresholds and which surround a 2×2 trigger tower core that is a local maximum. The location of this local maximum also defines the coordinates of the jet RoI.

In preparation for Run 2, due to the expected increase in luminosity and consequent increase in the number of pile-up events, a major upgrade of several central components of the L1Calo electronics was undertaken to reduce the trigger rates.

For the preprocessor system [20], which digitises and calibrates the analogue signals (consisting of ~ 7000 trigger towers at a granularity of 0.1×0.1 in $\eta \times \phi$) from the calorimeter detectors, a new FPGA-based multi-chip module (nMCM) was developed [21] and about 3000 chips (including spares) were produced. They replace the old ASIC-based MCMs used during Run 1. The new modules provide additional flexibility and new functionality with respect to the old system. In particular, the nMCMs support the use of digital autocorrelation Finite Impulse Response (FIR) filters and the implementation of a dynamic, bunch-by-bunch pedestal correction, both introduced for Run 2. These improvements lead to a significant rate reduction of the L1 jet and L1 E_T^{miss} triggers. The bunch-by-bunch pedestal subtraction compensates for the increased trigger rates at the beginning of a bunch train caused by the interplay of in-time and out-of-time pile-up coupled with the LAr pulse shape [22], and linearises the L1 trigger rate as a function of the instantaneous luminosity, as shown in Fig. 3 for the L1 E_T^{miss} trigger. The autocorrelation FIR filters substantially improve the bunch-crossing identification (BCID) efficiencies, in particular for low energy deposits. However, the use of this new filtering scheme initially led to an early trigger signal (and incomplete events) for a small fraction of very high energy events. These events were saved into a stream dedicated to mistimed events and treated separately in the relevant physics analyses. The source of the problem was fixed in firmware by adapting the BCID decision logic for saturated pulses and was deployed at the start of the 2016 data-taking period.

The preprocessor outputs are then transmitted to both the Cluster Processor (CP) and Jet/Energy-sum Processor (JEP) subsystems in parallel. The CP subsystem identifies electron/photon and tau lepton candidates with E_T above a programmable threshold and satisfying, if required, certain isolation criteria. The JEP receives jet trigger elements, which

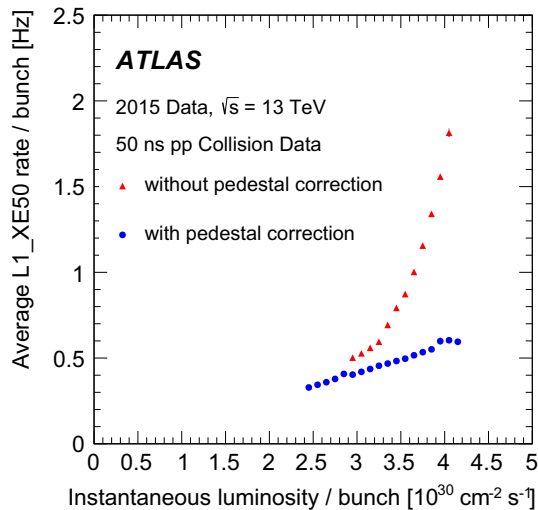

Fig. 3 The per-bunch trigger rate for the L1 missing transverse momentum trigger with a threshold of 50 GeV (L1_XE50) as a function of the instantaneous luminosity per bunch. The rates are shown with and without pedestal correction applied

are 0.2×0.2 sums in $\eta \times \phi$, and uses these to identify jets and to produce global sums of scalar and missing transverse momentum. Both the CP and JEP firmware were upgraded to allow an increase of the data transmission rate over the custom-made backplanes from 40 to 160 Mbps, allowing the transmission of up to four jet or five EM/tau trigger objects per module. A trigger object contains the E_T sum, $\eta - \phi$ coordinates, and isolation thresholds where relevant. While the JEP firmware changes were only minor, substantial extra selectivity was added to the CP by implementing energy-dependent L1 electromagnetic isolation criteria instead of fixed threshold cuts. This feature was added to the trigger menu (defined in Sect. 4) at the beginning of Run 2. In 2015 it was used to effectively select events with specific signatures, e.g. EM isolation was required for taus but not for electrons.

Finally, new extended cluster merger modules (CMX) were developed to replace the L1Calo merger modules (CMMs) used during Run 1. The new CMX modules transmit the location and the energy of identified trigger objects to the new L1Topo modules instead of only the threshold multiplicities as done by the CMMs. This transmission happens with a bandwidth of 6.4 Gbps per channel, while the total output bandwidth amounts to above 2 Tbps. Moreover, for most L1 triggers, twice as many trigger selections and isolation thresholds can be processed with the new CMX modules compared to Run 1, considerably increasing the selectivity of the L1Calo system.

3.2 Level-1 muon trigger

The muon barrel trigger was not significantly changed with respect to Run 1, apart from the regions close to the feet that

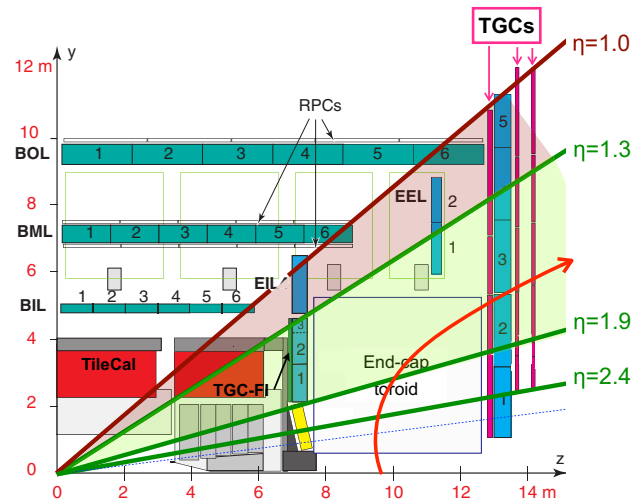

Fig. 4 A schematic view of the muon spectrometer with lines indicating various pseudorapidity regions. The curved arrow shows an example of a trajectory from slow particles generated at the beam pipe around $z \sim 10$ m. Triggers due to events of this type are mitigated by requiring an additional coincidence with the TGC-FI chambers in the region $1.3 < |\eta| < 1.9$

support the ATLAS detector, where the presence of support structures reduces trigger coverage. To recover trigger acceptance, a fourth layer of RPC trigger chambers was installed before Run 1 in the projective region of the acceptance holes. These chambers were not operational during Run 1. During LS1, these RPC layers were equipped with trigger electronics. Commissioning started during 2015 and they are fully operational in 2016. Additional chambers were installed during LS1 to cover the acceptance holes corresponding to two elevator shafts at the bottom of the muon spectrometer but are not yet operational. At the end of the commissioning phase, the new feet and elevator chambers are expected to increase the overall barrel trigger acceptance by 2.8 and 0.8% points, respectively.

During Run 1, a significant fraction of the trigger rate from the end-cap region was found to be due to particles not originating from the interaction point, as illustrated in Fig. 4. To reject these interactions, new trigger logic was introduced in Run 2. An additional TGC coincidence requirement was deployed in 2015 covering the region $1.3 < |\eta| < 1.9$ (TGC-FI). Further coincidence logic in the region $1.0 < |\eta| < 1.3$ is being commissioned by requiring coincidence with the inner TGC chambers (EIL4) or the Tile hadronic calorimeter. Figure 5a shows the muon trigger rate as a function of the muon trigger pseudorapidity with and without the TGC-FI coincidence in separate data-taking runs. The asymmetry as a function of η is a result of the magnetic field direction and the background particles being mostly positively charged. In the region where this additional coincidence is applied, the trigger rate is reduced by up to 60%

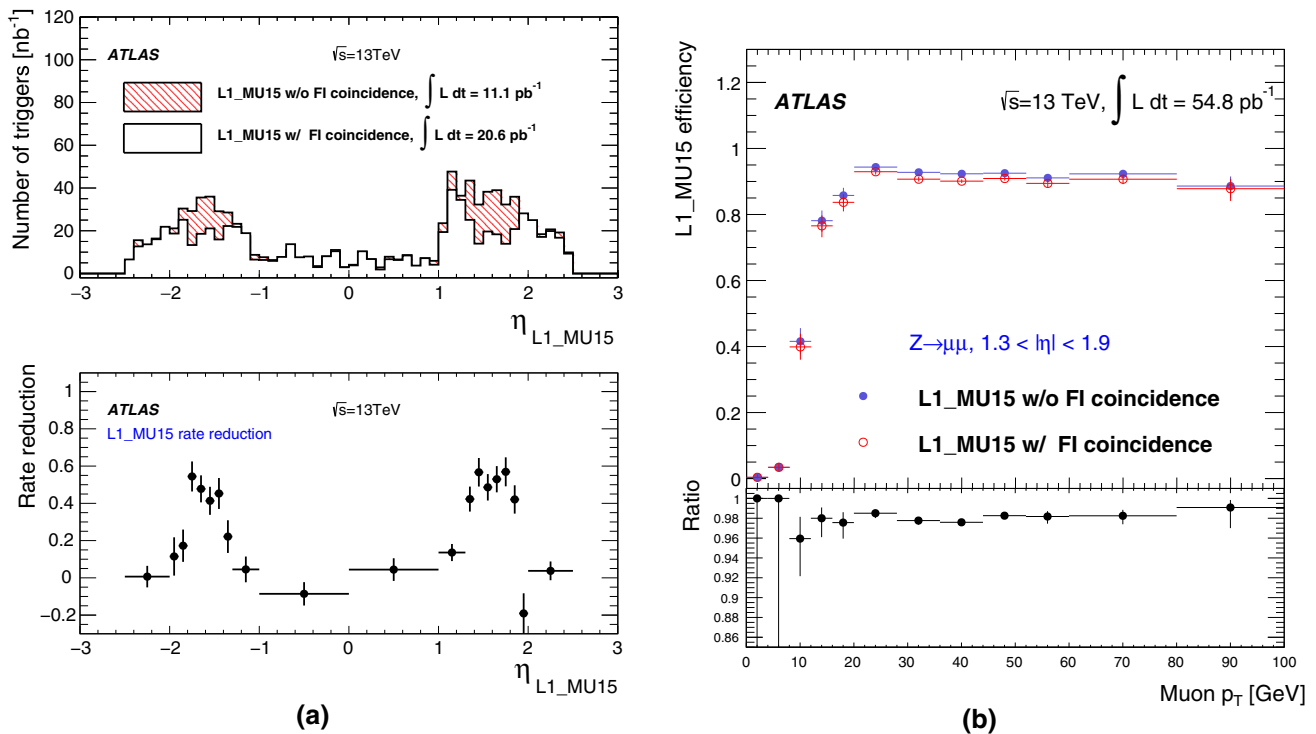

Fig. 5 **a** Number of events with an L1 muon trigger with transverse momentum (p_T) above 15 GeV ($L1_MU15$) as a function of the muon trigger η coordinate, requiring a coincidence with the TGC-FI chambers (*open histogram*) and not requiring it (*cross-hatched histogram*), together with the fractional event rate reduction in the *bottom plot*. The event rate reduction in the regions with no TGC-FI chambers is consis-

tent with zero within the uncertainty. **b** Efficiency of $L1_MU15$ in the end-cap region, as a function of the p_T of the offline muon measured via a tag-and-probe method (see Sect. 6) using $Z \rightarrow \mu\mu$ events with (*open dots*) and without (*filled dots*) the TGC-FI coincidence, together with the ratio in the *bottom panel*

while only about 2% of offline reconstructed muons are lost in this region, as seen in Fig. 5b.

4 Trigger menu

The trigger menu defines the list of L1 and HLT triggers and consists of:

- *primary* triggers, which are used for physics analyses and are typically unprescaled;
- *support* triggers, which are used for efficiency and performance measurements or for monitoring, and are typically operated at a small rate (of the order of 0.5 Hz each) using prescale factors;
- *alternative* triggers, using alternative (sometimes experimental or new) reconstruction algorithms compared to the primary or support selections, and often heavily overlapping with the primary triggers;
- *backup* triggers, with tighter selections and lower expected rate;
- *calibration* triggers, which are used for detector calibration and are often operated at high rate but storing very

small events with only the relevant information needed for calibration.

The primary triggers cover all signatures relevant to the ATLAS physics programme including electrons, photons, muons, tau leptons, (b -)jets and E_T^{miss} which are used for Standard Model (SM) precision measurements including decays of the Higgs, W and Z bosons, and searches for physics beyond the SM such as heavy particles, supersymmetry or exotic particles. A set of low transverse momentum (p_T) dimuon triggers is used to collect B -meson decays, which are essential for the B -physics programme of ATLAS.

The trigger menu composition and trigger thresholds are optimised for several luminosity ranges in order to maximise the physics output of the experiment and to fit within the rate and bandwidth constraints of the ATLAS detector, TDAQ system and offline computing. For Run 2 the most relevant constraints are the maximum L1 rate of 100 kHz (75 kHz in Run 1) defined by the ATLAS detector readout capability and an average HLT physics output rate of 1000 Hz (400 Hz in Run 1) defined by the offline computing model. To ensure an optimal trigger menu within the rate constraints for a given LHC luminosity, prescale factors can be applied to L1 and

HLT triggers and changed during data-taking in such a way that triggers may be disabled or only a certain fraction of events may be accepted by them. Supporting triggers may be running at a constant rate or certain triggers enabled later in the LHC fill when the luminosity and pile-up has reduced and the required resources are available. Further flexibility is provided by *bunch groups*, which allow triggers to include specific requirements on the LHC proton bunches colliding in ATLAS. These requirements include paired (colliding) bunch-crossings for physics triggers, empty or unpaired crossings for background studies or search for long-lived particle decays, and dedicated bunch groups for detector calibration.

Trigger names used throughout this paper consist of the trigger level (L1 or HLT, the latter often omitted for brevity), multiplicity, particle type (e.g. γ for photon, j for jet, χ_e for E_T^{miss} , τ_e for $\sum E_T$ triggers) and p_T threshold value in GeV (e.g. L1_2MU4 requires at least two muons with $p_T > 4$ GeV at L1, HLT_mu40 requires at least one muon with $p_T > 40$ GeV at the HLT). L1 and HLT trigger items are written in upper case and lower case letters, respectively. Each HLT trigger is configured with an L1 trigger as its seed. The L1 seed is not explicitly part of the trigger name except

when an HLT trigger is seeded by more than one L1 trigger, in which case the L1 seed is denoted in the suffix of the alternative trigger (e.g. HLT_mu20 and HLT_mu20_L1MU15 with the first one using L1_MU20 as its seed). Further selection criteria (type of identification, isolation, reconstruction algorithm, geometrical region) are suffixed to the trigger name (e.g. HLT_g120_loose).

4.1 Physics trigger menu for 2015 data-taking

The main goal of the trigger menu design was to maintain the unrescaled single-electron and single-muon trigger p_T thresholds around 25 GeV despite the expected higher trigger rates in Run 2 (see Sect. 3). This strategy ensures the collection of the majority of the events with leptonic W and Z boson decays, which are the main source of events for the study of electroweak processes. In addition, compared to using a large number of analysis-specific triggers, this trigger strategy is simpler and more robust at the cost of slightly higher trigger output rates. Dedicated (multi-object) triggers were added for specific analyses not covered by the above. Table 1 shows a comparison of selected primary trigger thresholds for L1 and the HLT used during Run 1 and 2015 together

Table 1 Comparison of selected primary trigger thresholds (in GeV) at the end of Run 1 and during 2015 together with typical offline requirements applied in analyses (the 2012 offline thresholds are not listed but have a similar relationship to the 2012 HLT thresholds). Electron and tau identification are assumed to fulfil the ‘medium’ criteria unless otherwise stated. Photon and b -jet identification (‘b’) are assumed to fulfil the ‘loose’ criteria. Trigger isolation is denoted by ‘i’. The details of these selections are described in Sect. 6

Category	2012		2015		
	\sqrt{s}		\sqrt{s}		
	8 TeV		13 TeV		
Peak luminosity	$7.7 \times 10^{33} \text{ cm}^{-2} \text{ s}^{-1}$		$5.0 \times 10^{33} \text{ cm}^{-2} \text{ s}^{-1}$		
	p_T threshold [GeV], criteria				
	L1	HLT	L1	HLT	Offline
Single electron	18	24i	20	24	25
Single muon	15	24i	15	20i	21
Single photon	20	120	22i	120	125
Single tau	40	115	60	80	90
Single jet	75	360	100	360	400
Single b -jet	n/a	n/a	100	225	235
E_T^{miss}	40	80	50	70	180
Dielectron	2×10	2×12 , loose	2×10	2×12 , loose	15
Dimuon	2×10	2×13	2×10	2×10	11
Electron, muon	10, 6	12, 8	15, 10	17, 14	19, 15
Diphoton	16, 12	35, 25	2×15	35, 25	40, 30
Ditau	15i, 11i	27, 18	20i, 12i	35, 25	40, 30
Tau, electron	11i, 14	28i, 18	12i(+jets), 15	25, 17i	30, 19
Tau, muon	8, 10	20, 15	12i(+jets), 10	25, 14	30, 15
Tau, E_T^{miss}	20, 35	38, 40	20, 45(+jets)	35, 70	40, 180
Four jets	4×15	4×80	3×40	4×85	95
Six jets	4×15	6×45	4×15	6×45	55
Two b -jets	75	35b, 145b	100	50b, 150b	60
Four(Two) (b -)jets	4×15	$2 \times 35b$, 2×35	3×25	$2 \times 35b$, 2×35	45
B -physics (Dimuon)	6, 4	6, 4	6, 4	6, 4	6, 4

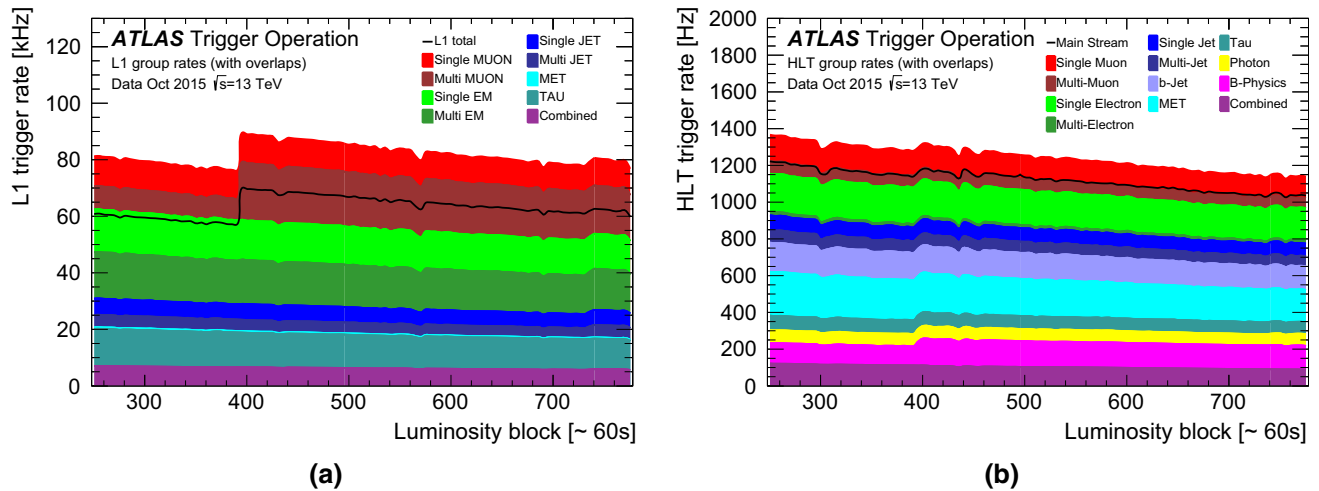

Fig. 6 **a** L1 and **b** HLT trigger rates grouped by trigger signature during an LHC fill in October 2015 with a peak luminosity of $4.5 \times 10^{33} \text{ cm}^{-2} \text{ s}^{-1}$. Due to overlaps the sum of the individual groups is higher than the **a** L1 total rate and **b** Main physics stream rate, which are shown as *black lines*. Multi-object triggers are included in the *b*-jets

with the typical thresholds for offline reconstructed objects used in analyses (the latter are usually defined as the p_T value at which the trigger efficiency reached the plateau). Trigger thresholds at L1 were either kept the same as during Run 1 or slightly increased to fit within the allowed maximum L1 rate of 100 kHz. At the HLT, several selections were loosened compared to Run 1 or thresholds lowered thanks to the use of more sophisticated HLT algorithms (e.g. multivariate analysis techniques for electrons and taus).

Figure 6a, b show the L1 and HLT trigger rates grouped by signatures during an LHC fill with a peak luminosity of $4.5 \times 10^{33} \text{ cm}^{-2} \text{ s}^{-1}$. The preventive dead-time² The single-electron and single-muon triggers contribute a large fraction to the total rate. While running at these relatively low luminosities it was possible to dedicate a large fraction of the bandwidth to the *B*-physics triggers. Support triggers contribute about 20% of the total rate. Since the time for trigger commissioning in 2015 was limited due to the fast rise of the LHC luminosity (compared to Run 1), several backup triggers, which contribute additional rate, were implemented in the menu in addition to the primary physics triggers. This is the case for electron, *b*-jet and E_T^{miss} triggers, which are discussed in later sections of the paper.

4.2 Event streaming

Events accepted by the HLT are written into separate data *streams*. Events for physics analyses are sent to a single

² The four complex dead-time settings were 15/370, 42/381, 9/351 and 7/350, where the first number specifies the number of triggers and the second number specifies the number of bunch-crossings, e.g. 7 triggers in 350 bunch-crossings.

and tau groups. The rate increase around luminosity block 400 is due to the removal of prescaling of the *B*-physics triggers. The combined group includes multiple triggers combining different trigger signatures such as electrons with muons, taus, jets or E_T^{miss}

Main stream replacing the three separate physics streams (*Egamma*, *Muons*, *JetTauEtMiss*) used in Run 1. This change reduces event duplication, thus reducing storage and CPU resources required for reconstruction by roughly 10%. A small fraction of these events at a rate of 10 to 20 Hz are also written to an *Express* stream that is reconstructed promptly offline and used to provide calibration and data quality information prior to the reconstruction of the full *Main* stream, which typically happens 36 h after the data are taken. In addition, there are about twenty additional streams for calibration, monitoring and detector performance studies. To reduce event size, some of these streams use partial event building (partial EB), which writes only a predefined subset of the ATLAS detector data per event. For Run 2, events that contain only HLT reconstructed objects, but no ATLAS detector data, can be recorded to a new type of stream. These events are of very small size, allowing recording at high rate. These streams are used for calibration purposes and *Trigger-Level Analysis* as described in Sect. 6.4.4. Figure 7 shows typical HLT stream rates and bandwidth during an LHC fill.

Events that cannot be properly processed at the HLT or have other DAQ-related problems are written to dedicated *debug* streams. These events are reprocessed offline with the same HLT configuration as used during data-taking and accepted events are stored into separate data sets for use in physics analyses. In 2015, approximately 339,000 events were written to debug streams. The majority of them (~90%) are due to online processing timeouts that occur when the event cannot be processed within 2–3 min. Long processing times are mainly due to muon algorithms processing events with a large number of tracks in the muon spectrometer (e.g. due to jets not contained in the calorimeter). During the debug

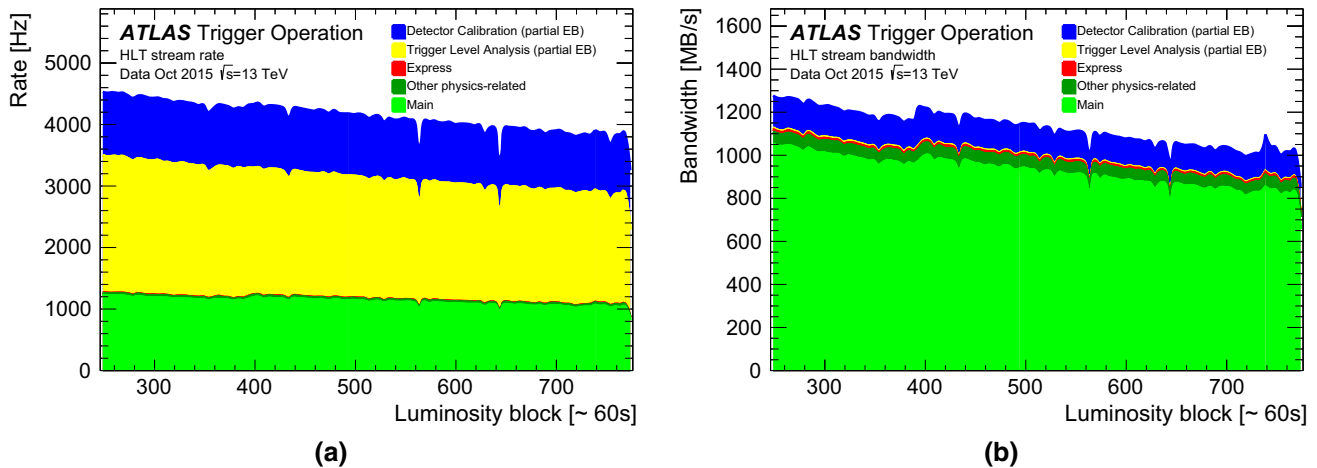

Fig. 7 **a** HLT stream rates and **b** bandwidth during an LHC fill in October 2015 with a peak luminosity of $4.5 \times 10^{33} \text{ cm}^{-2} \text{ s}^{-1}$. Partial Event Building (partial EB) streams only store relevant subdetector data and

stream reprocessing, 330,000 events were successfully processed by the HLT of which about 85% were accepted. The remaining 9000 events could not be processed due to data integrity issues.

4.3 HLT processing time

The HLT processing time per event is mainly determined by the trigger menu and the number of pile-up interactions. The HLT farm CPU utilisation depends on the L1 trigger rate and the average HLT processing time. Figure 8 shows (a) the HLT processing time distribution for the highest luminosity run in 2015 with a peak luminosity of $5.2 \times 10^{33} \text{ cm}^{-2} \text{ s}^{-1}$ and (b) the average HLT processing time as a function of the instantaneous luminosity. At the highest luminosity point the average event processing time was approximately 235 ms. An L1 rate of 80 kHz corresponds to an average utilisation of 67% of a farm with 28,000 available CPU cores. About 40, 35 and 15% of the processing time are spent on inner detector tracking, muon spectrometer reconstruction and calorimeter reconstruction, respectively. The muon reconstruction time is dominated by the large rate of low- p_T B -physics triggers. The increased processing time at low luminosities observed in Fig. 8b is due to additional triggers being enabled towards the end of an LHC fill to take advantage of the available CPU and bandwidth resources. Moreover, trigger prescale changes are made throughout the run giving rise to some of the observed features in the curve. The clearly visible scaling with luminosity is due to the pileup dependence of the processing time. It is also worth noting that the processing time cannot naively be scaled to higher luminosities as the trigger menu changes significantly in order to keep the L1 rate below or at 100 kHz.

thus have smaller event sizes. The other physics-related streams contain events with special readout settings and are used to overlay with MC events to simulate pile-up

4.4 Trigger menu for special data-taking conditions

Special trigger menus are used for particular data-taking conditions and can either be required for collecting a set of events for dedicated measurements or due to specific LHC bunch configurations. In the following, three examples of dedicated menus are given: menu for low number of bunches in the LHC, menu for collecting enhanced minimum-bias data for trigger rate predictions and menu during beam separation scans for luminosity calibration (van der Meer scans).

When the LHC contains a low number of bunches (and thus few bunch trains), care is needed not to trigger at resonant frequencies that could damage the wire bonds of the IBL or SCT detectors, which reside in the magnetic field. The dangerous resonant frequencies are between 9 and 25 kHz for the IBL and above 100 kHz for the SCT detector. To avoid this risk, both detectors have implemented in the readout firmware a so-called fixed frequency veto that prevents triggers falling within a dangerous frequency range [23]. The IBL veto poses the most stringent limit on the acceptable L1 rate in this LHC configuration. In order to provide trigger menus appropriate to each LHC configuration during the startup phase, the trigger rate has been estimated after simulating the effect of the IBL veto. Figure 9 shows the simulated IBL rate limit for two different bunch configurations and the expected L1 trigger rate of the nominal physics trigger menu. At a low number of bunches the expected L1 trigger rate exceeds slightly the allowed L1 rate imposed by the IBL veto. In order not to veto important physics triggers, the required rate reduction was achieved by reducing the rate of supporting triggers.

Certain applications such as trigger algorithm development, rate predictions and validation require a data set that is

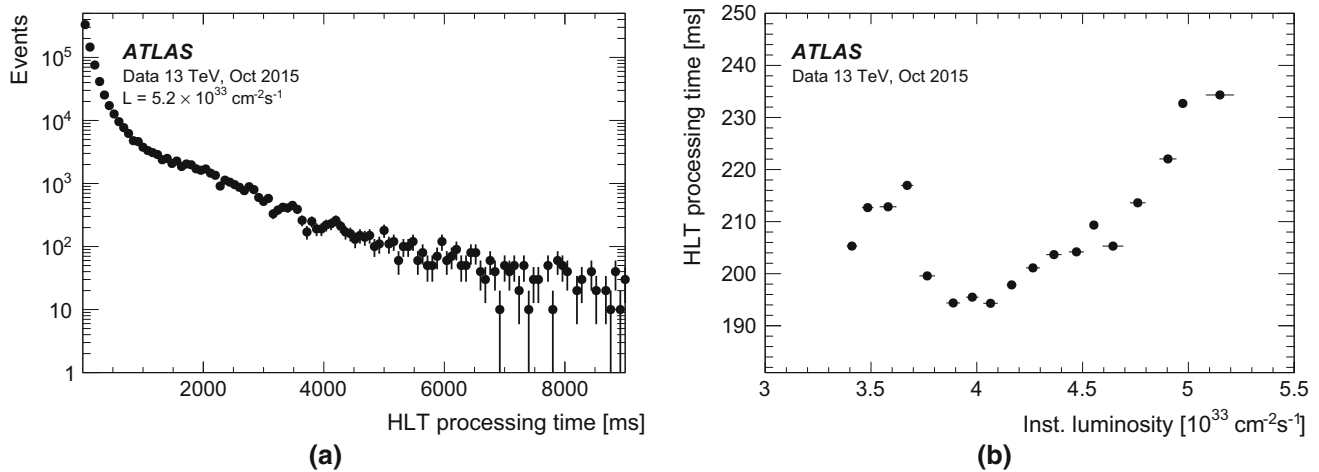

Fig. 8 **a** HLT processing time distribution per event for an instantaneous luminosity of $5.2 \times 10^{33} \text{ cm}^{-2} \text{ s}^{-1}$ and average pile-up $\langle\mu\rangle = 15$ and **b** mean HLT processing time as a function of the instantaneous luminosity

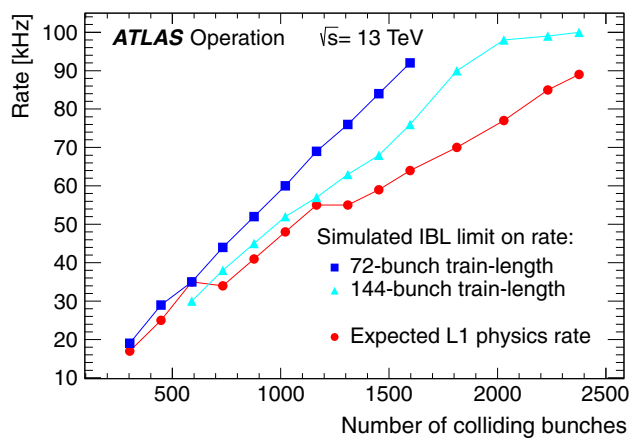

Fig. 9 Simulated limits on the L1 trigger rate due to the IBL fixed frequency veto for two different filling schemes and the expected maximum L1 rate from rate predictions. The steps in the latter indicate a change in the prescale strategy. The simulated rate limit is confirmed with experimental tests. The rate limit is higher for the 72-bunch train configuration since the bunches are more equally spread across the LHC ring. The rate limitation was only crucial for the low luminosity phase, where the required physics L1 rate was higher than the limit imposed by the IBL veto. The maximum number of colliding bunches in 2015 was 2232

minimally biased by the triggers used to select it. This special data set is collected using the enhanced minimum-bias trigger menu, which consists of all primary lowest- p_T L1 triggers with increasing p_T threshold and a random trigger for very high cross-section processes. This trigger menu can be enabled in addition to the regular physics menu and records events at 300 Hz for a period of approximately one hour to obtain a data set of around one million events. Since the correlations between triggers are preserved, per-event weights can be calculated and used to convert the sample into a zero-bias sample, which is used for trigger rate predictions during

the development of new triggers [24]. This approach requires a much smaller total number of events than a true zero-bias data set.

During van der Meer scans [25], which are performed by the LHC to allow the experiments to calibrate their luminosity measurements, a dedicated trigger menu is used. ATLAS uses several luminosity algorithms (see Ref. [26]) amongst which one relies on counting tracks in the ID. Since the different LHC bunches do not have the exact same proton density, it is beneficial to sample a few bunches at the maximum possible rate. For this purpose, a minimum-bias trigger selects events for specific LHC bunches and uses partial event building to read out only the ID data at about 5 kHz for five different LHC bunches.

5 High-level trigger reconstruction

After L1 trigger acceptance, the events are processed by the HLT using finer-granularity calorimeter information, precision measurements from the MS and tracking information from the ID, which are not available at L1. As needed, the HLT reconstruction can either be executed within RoIs identified at L1 or for the full detector. In both cases the data is retrieved on demand from the readout system. As in Run 1, in order to reduce the processing time, most HLT triggers use a two-stage approach with a fast first-pass reconstruction to reject the majority of events and a slower precision reconstruction for the remaining events. However, with the merging of the previously separate L2 and EF farms, there is no longer a fixed bandwidth or rate limitation between the two steps. The following sections describe the main reconstruction algorithms used in the HLT for inner detector, calorimeter and muon reconstruction.

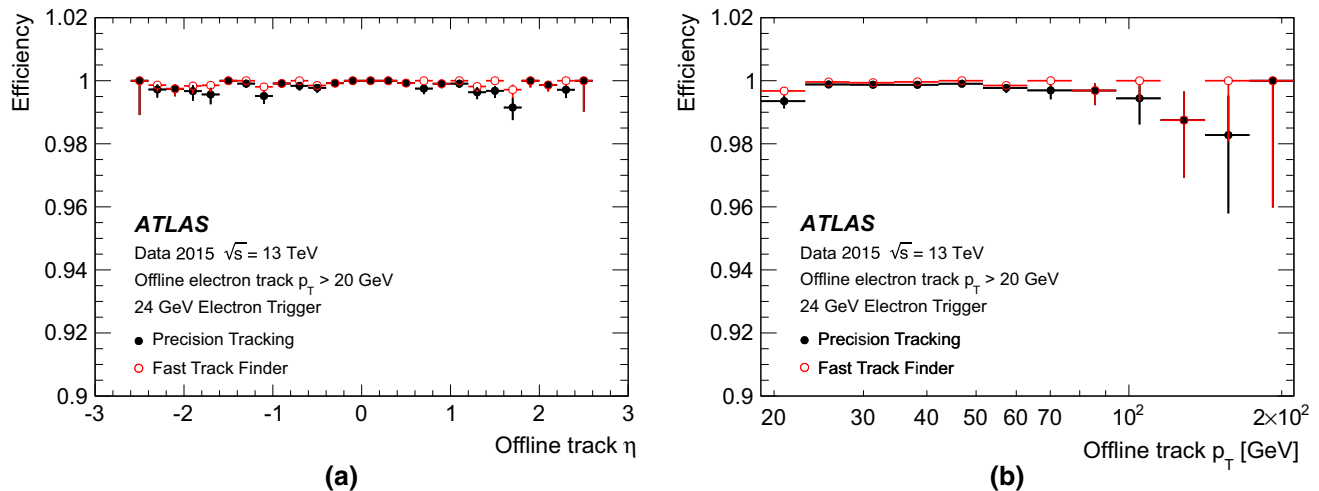

Fig. 10 The ID tracking efficiency for the 24 GeV electron trigger is shown as a function of the **a** η and **b** p_T of the track of the offline electron candidate. Uncertainties based on Bayesian statistics are shown

5.1 Inner detector tracking

For Run 1 the ID tracking in the trigger consisted of custom tracking algorithms at L2 and offline tracking algorithms adapted for running in the EF. The ID trigger was redesigned for Run 2 to take advantage of the merged HLT and include information from the IBL. The latter significantly improves the tracking performance and in particular the impact parameter resolution [7]. In addition, provision was made for the inclusion of FTK tracks once that system becomes available later in Run 2.

5.1.1 Inner detector tracking algorithms

The tracking trigger is subdivided into *fast tracking* and *precision tracking* stages. The fast tracking consists of trigger-specific pattern recognition algorithms very similar to those used at L2 during Run 1, whereas the precision stage relies heavily on offline tracking algorithms. Despite similar naming the fast tracking as described here is not related to the FTK hardware tracking that will only become available during 2017. The tracking algorithms are typically configured to run within an RoI identified by L1. The offline tracking was reimplemented in LS1 to run three times faster than in Run 1, making it more suitable to use in the HLT. To reduce CPU usage even further, the offline track-finding is seeded by tracks and space-points identified by the fast tracking stage.

5.1.2 Inner detector tracking performance

The tracking efficiency with respect to offline tracks has been determined for electrons and muons. The reconstructed tracks are required to have at least two (six) pixel (SCT) clusters and lie in the region $|\eta| < 2.5$. The closest trigger track

within a cone of size $\Delta R = \sqrt{(\Delta\eta)^2 + (\Delta\phi)^2} = 0.05$ of the offline reconstructed track is selected as the matching trigger track.

Figure 10 shows the tracking efficiency for the 24 GeV medium electron trigger (see Sect. 6.2) as a function of the η and of the p_T of the offline track. The tracking efficiency is measured with respect to offline tracks with $p_T > 20$ GeV for tight offline electron candidates from the 24 GeV electron support trigger, which does not use the trigger tracks in the selection, but is otherwise identical to the physics trigger. The efficiencies of the fast track finder and precision tracking exceed 99% for all pseudorapidities. There is a small efficiency loss at low p_T due to bremsstrahlung energy loss by electrons.

Figure 11a shows the tracking performance of the ID trigger for muons with respect to loose offline muon candidates with $p_T > 6$ GeV selected by the 6 GeV muon support trigger as a function of the offline muon transverse momentum. The efficiency is significantly better than 99% for all p_T for both the fast and precision tracking. Shown in Fig. 11b is the resolution of the transverse track impact parameter with respect to offline as a function of the offline muon p_T . The resolution in the fast (precision) tracking is better than $17 \mu\text{m}$ ($15 \mu\text{m}$) for muon candidates with offline $p_T > 20$ GeV.

5.1.3 Multiple stage tracking

For the hadronic tau and b -jet triggers, tracking is run in a larger RoI than for electrons or muons. To limit CPU usage, multiple stage track reconstruction was implemented.

A two-stage processing approach was implemented for the hadronic tau trigger. First, the leading track and its position along the beamline are determined by executing fast tracking in an RoI that is fully extended along the beam-

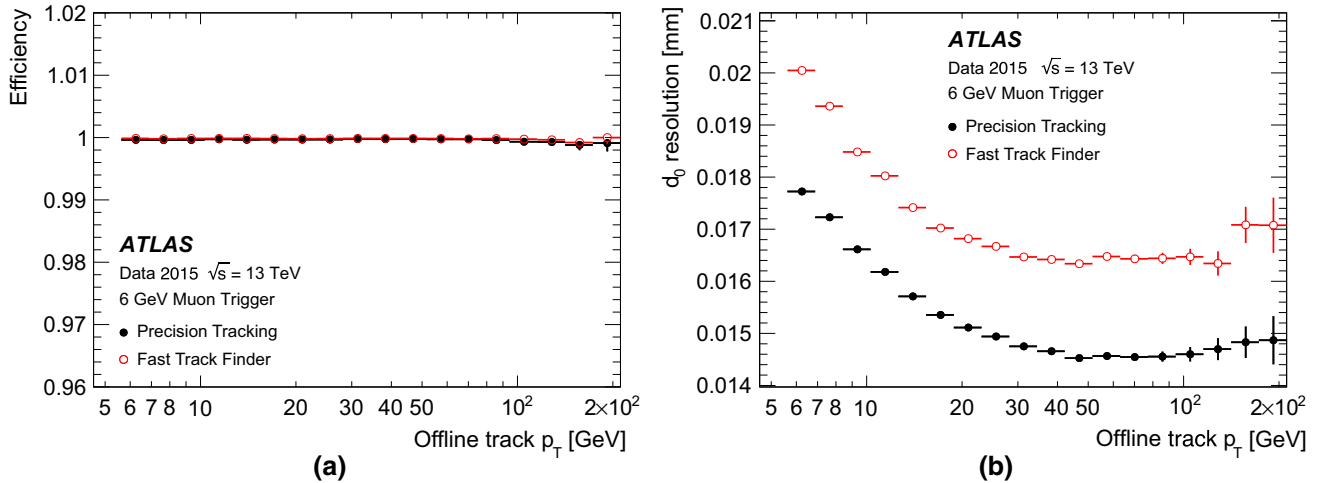

Fig. 11 The ID tracking performance for the 6 GeV muon trigger; **a** efficiency as a function of the offline reconstructed muon p_T , **b** the resolution of the transverse impact parameter, d_0 as a function of the offline reconstructed muon p_T . Uncertainties based on Bayesian statistics are shown

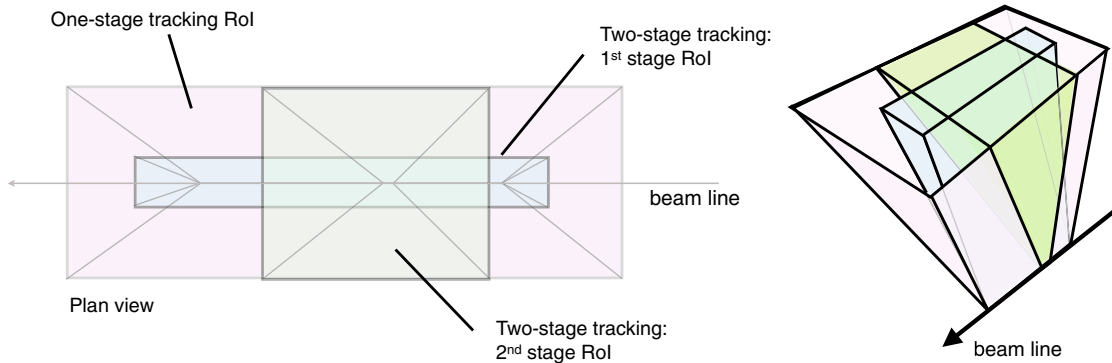

Fig. 12 A schematic illustrating the RoIs from the single-stage and two-stage tau lepton trigger tracking, shown in plan view (x - z plane) along the transverse direction and in perspective view. The z -axis is

along the beam line. The combined tracking volume of the 1st and 2nd stage RoI in the two-stage tracking approach is significantly smaller than the RoI in the one-stage tracking scheme

line ($|z| < 225$ mm) but narrow (0.1) in both η and ϕ . (See the blue-shaded region in Fig. 12.) Using this position along the beamline, the second stage reconstructs all tracks in an RoI that is larger (0.4) in both η and ϕ but limited to $|\Delta z| < 10$ mm with respect to the leading track. (See the green shaded region in Fig. 12.) At this second stage, fast tracking is followed by precision tracking. For evaluation purposes, the tau lepton signatures can also be executed in a single-stage mode, running the fast track finder followed by the precision tracking in an RoI of the full extent along the beam line and in eta and phi.

Figure 13 shows the performance of the tau two-stage tracking with respect to the offline tau tracking for tracks with $p_T > 1$ GeV originating from decays of offline tau lepton candidates with $p_T > 25$ GeV, but with very loose track matching in ΔR to the offline tau candidate. Figure 13a shows the efficiency of the fast tracking from the first and second stages, together with the efficiency of the precision tracking

for the second stage. The second-stage tracking efficiency is higher than 96% everywhere, and improves to better than 99% for tracks with $p_T > 2$ GeV. The efficiency of the first-stage fast tracking has a slower turn-on, rising from 94% at 2 GeV to better than 99% for $p_T > 5$ GeV. This slow turn-on arises due to the narrow width ($\Delta\phi < 0.1$) of the first-stage RoI and the loose tau selection that results in a larger fraction of low- p_T tracks from tau candidates that bend out of the RoI (and are not reconstructed) compared to a wider RoI. The transverse impact parameter resolution with respect to offline for loosely matched tracks is seen in Fig. 13b and is around 20 μm for tracks with $p_T > 10$ GeV reconstructed by the precision tracking. The tau selection algorithms based on this two-stage tracking are presented in Sect. 6.5.1.

For b -jet tracking a similar multi-stage tracking strategy was adopted. However, in this case the first-stage vertex tracking takes all jets identified by the jet trigger with $E_T > 30$ GeV and reconstructs tracks with the fast track

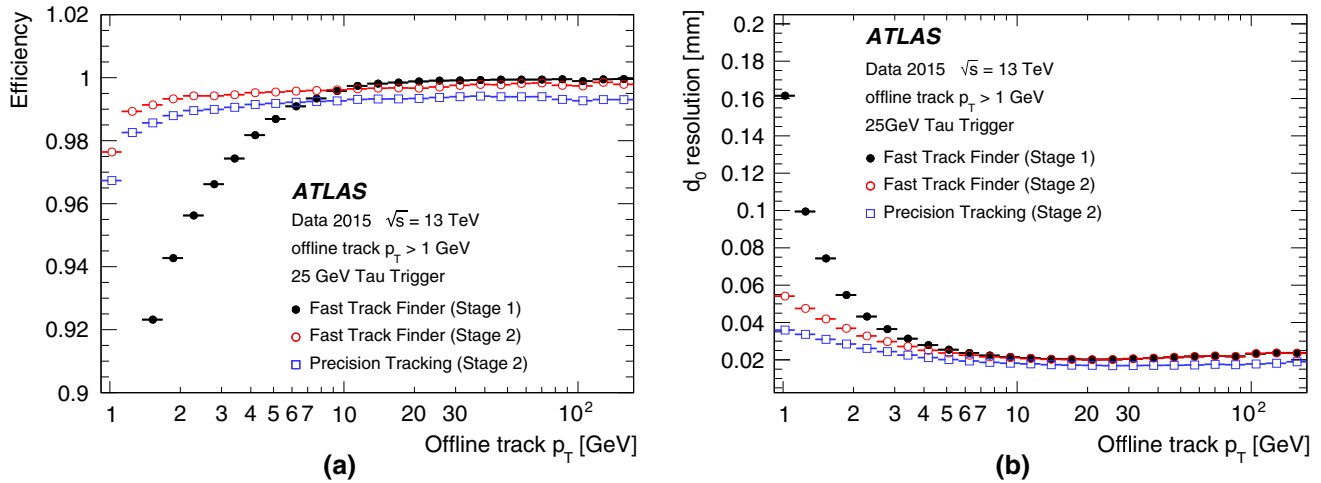

Fig. 13 The ID trigger tau tracking performance with respect to offline tracks from very loose tau candidates with $p_T > 1$ GeV from the 25 GeV tau trigger; **a** the efficiency as a function of the offline reconstructed tau track p_T , **b** the resolution of the transverse impact parameter, d_0 as a function of the offline reconstructed tau track p_T . The offline recon-

structed tau daughter tracks are required to have $p_T > 1$ GeV, lie in the region $|\eta| < 2.5$ and have at least two pixel clusters and at least six SCT clusters. The closest matching trigger track within a cone of size $\Delta R = 0.05$ of the offline track is selected as the matching trigger track

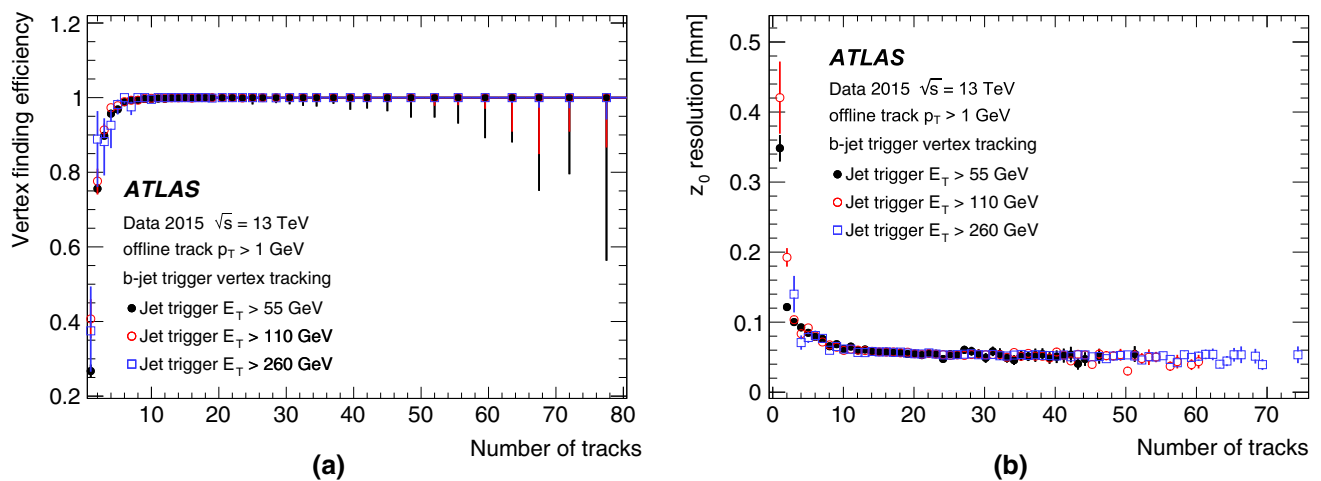

Fig. 14 The trigger performance for primary vertices in the b -jet signatures for 55, 110 and 260 GeV jet triggers; **a** the vertexing efficiency as a function of the number of offline tracks within the jets used for the

vertex tracking, **b** the resolution in z of the vertex with respect to the offline vertex position as a function of the number of offline tracks from the offline vertex

finder in a narrow region in η and ϕ around the jet axis for each jet, but with $|z| < 225$ mm along the beam line. Following this step, the primary vertex reconstruction [27] is performed using the tracks from the fast tracking stage. This vertex is used to define wider RoIs around the jet axes, with $|\Delta\eta| < 0.4$ and $|\Delta\phi| < 0.4$ but with $|\Delta z| < 20$ mm relative to the primary vertex z position. These RoIs are then used for the second-stage reconstruction that runs the fast track finder in the wider η and ϕ regions followed by the precision tracking, secondary vertexing and b -tagging algorithms.

The performance of the primary vertexing in the b -jet vertex tracking can be seen in Fig. 14a, which shows the vertex

finding efficiency with respect to offline vertices in jet events with at least one jet with transverse energy above 55, 110, or 260 GeV and with no additional b -tagging requirement. The efficiency is shown as a function of the number of offline tracks with $p_T > 1$ GeV that lie within the boundary of the wider RoI (defined above) from the selected jets. The efficiency rises sharply and is above 90% for vertices with three or more tracks, and rises to more than 99.5% for vertices with five or more tracks. The resolution in z with respect to the offline z position as shown in Fig. 14b is better than 100 μm for vertices with two or more offline tracks and improves to 60 μm for vertices with ten or more offline tracks.

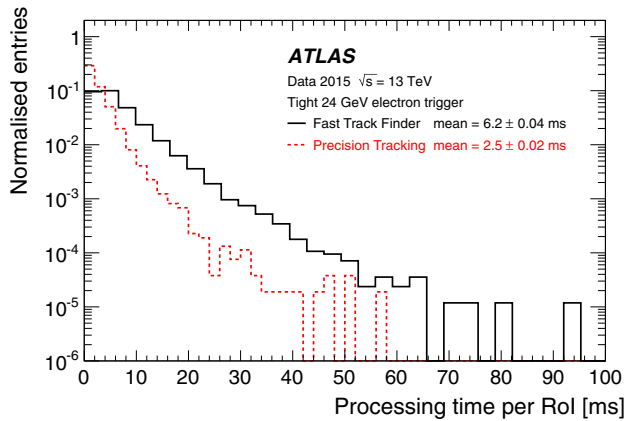

Fig. 15 The CPU processing time for the fast and precision tracking per electron RoI for the 24 GeV electron trigger. The precision tracking is seeded by the tracks found in the fast tracking stage and hence requires less CPU time

5.1.4 Inner detector tracking timing

The timing of the fast tracking and precision tracking stages of the electron trigger executed per RoI can be seen in Fig. 15 for events passing the 24 GeV electron trigger. The fast tracking takes on average 6.2 ms per RoI with a tail at the per-mille level at around 60 ms. The precision tracking execution time has a mean of 2.5 ms and a tail at the per-mille level of around 20 ms. The precision tracking is seeded by the tracks found in the fast tracking stage and hence requires less CPU time.

The time taken by the tau tracking in both the single-stage and two-stage variants is shown in Fig. 16. Figure 16a shows the processing times per RoI for fast tracking stages: individually for the first and second stages of the two-stage tracking, and separately for the single-stage tracking with the wider RoI in η , ϕ and z . The fast tracking in the single-stage tracking has a mean execution time of approximately 66 ms,

with a very long tail. In contrast, the first-stage tracking with an RoI that is wide only in the z direction has a mean execution time of 23 ms, driven predominantly by the narrower RoI width in ϕ . The second-stage tracking, although wider in η and ϕ , takes only 21 ms on average because of the significant reduction in the RoI z -width along the beam line. Figure 16b shows a comparison of the processing time per RoI for the precision tracking. The two-stage tracking executes faster, with a mean of 4.8 ms compared to 12 ms for the single-stage tracking. Again, this is due to the reduction in the number of tracks to be processed from the tighter selection in z along the beam line.

5.2 Calorimeter reconstruction

A series of reconstruction algorithms are used to convert signals from the calorimeter readout into objects, specifically cells and clusters, that then serve as input to the reconstruction of electron, photon, tau, and jet candidates and the reconstruction of E_T^{miss} . These cells and clusters are also used in the determination of the shower shapes and the isolation properties of candidate particles (including muons), both of which are later used as discriminants for particle identification and the rejection of backgrounds. The reconstruction algorithms used in the HLT have access to full detector granularity and thus allow improved accuracy and precision in energy and position measurements with respect to L1.

5.2.1 Calorimeter algorithms

The first stage in the reconstruction involves unpacking the data from the calorimeter. The unpacking can be done in two different ways: either by unpacking only the data from within the RoIs identified at L1 or by unpacking the data from the full calorimeter. The RoI-based approach is used for well-

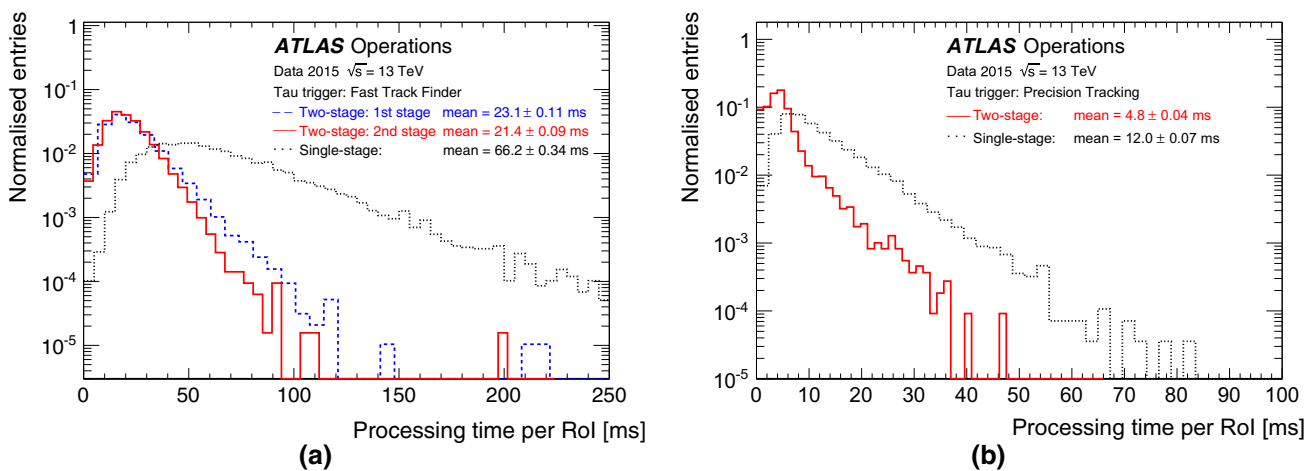

Fig. 16 The ID trigger tau tracking processing time for **a** the fast track finder and **b** the precision tracking comparing the single-stage and two-stage tracking approach

separated objects (e.g. electron, photon, muon, tau), whereas the full calorimeter reconstruction is used for jets and global event quantities (e.g. E_T^{miss}). In both cases the raw unpacked data is then converted into a collection of cells. Two different clustering algorithms are used to reconstruct the clusters of energy deposited in the calorimeter, the sliding-window and the topo-clustering algorithms [28]. While the latter provides performance closer to the offline reconstruction, it is also significantly slower (see Sect. 5.2.3).

The sliding-window algorithm operates on a grid in which the cells are divided into projective towers. The algorithm scans this grid and positions the window in such a way that the transverse energy contained within the window is the local maximum. If this local maximum is above a given threshold, a cluster is formed by summing the cells within a rectangular clustering window. For each layer the barycentre of the cells within that layer is determined, and then all cells within a fixed window around that position are included in the cluster. Although the size of the clustering window is fixed, the central position of the window may vary slightly at each calorimeter layer, depending on how the cell energies are distributed within them.

The topo-clustering algorithm begins with a seed cell and iteratively adds neighbouring cells to the cluster if their energies are above a given energy threshold that is a function of the expected root-mean-square (RMS) noise (σ). The seed cells are first identified as those cells that have energies greater than 4σ . All neighbouring cells with energies greater than 2σ are then added to the cluster and, finally, all the remaining neighbours to these cells are also added. Unlike the sliding-window clusters, the topo-clusters have no predefined shape, and consequently their size can vary from cluster to cluster.

The reconstruction of candidate electrons and photons uses the sliding-window algorithm with rectangular clustering windows of size $\Delta\eta \times \Delta\phi = 0.075 \times 0.175$ in the barrel and 0.125×0.125 in the end-caps. Since the magnetic field bends the electron trajectory in the ϕ direction, the size of the window is larger in that coordinate in order to contain most of the energy. The reconstruction of candidate taus and jets and the reconstruction of E_T^{miss} all use the topo-clustering algorithm. For taus the topo-clustering uses a window of 0.8×0.8 around each of the tau RoIs identified at L1. For jets and E_T^{miss} , the topo-clustering is done for the full calorimeter. In addition, the E_T^{miss} is also determined based on the cell energies across the full calorimeter (see Sect. 6.6).

5.2.2 Calorimeter algorithm performance

The harmonisation between the online and offline algorithms in Run 2 means that the online calorimeter performance is now much closer to the offline performance. The E_T resolutions of the sliding-window clusters and the topo-clusters with respect to their offline counterparts are shown in Fig. 17. The E_T resolution of the sliding-window clusters is 3% for clusters above 5 GeV, while the E_T resolution of the topo-clustering algorithm is 2% for clusters above 10 GeV. The slight shift in cell energies between the HLT and offline is due to the fact that out-of-time pile-up effects were not corrected in the online reconstruction, resulting in slightly higher reconstructed cell energies in the HLT (this was changed for 2016). In addition, the topo-cluster based reconstruction shown in Fig. 17b suffered from a mismatch of some calibration constants between online and offline during most of 2015, resulting in a shift towards lower HLT cell energies.

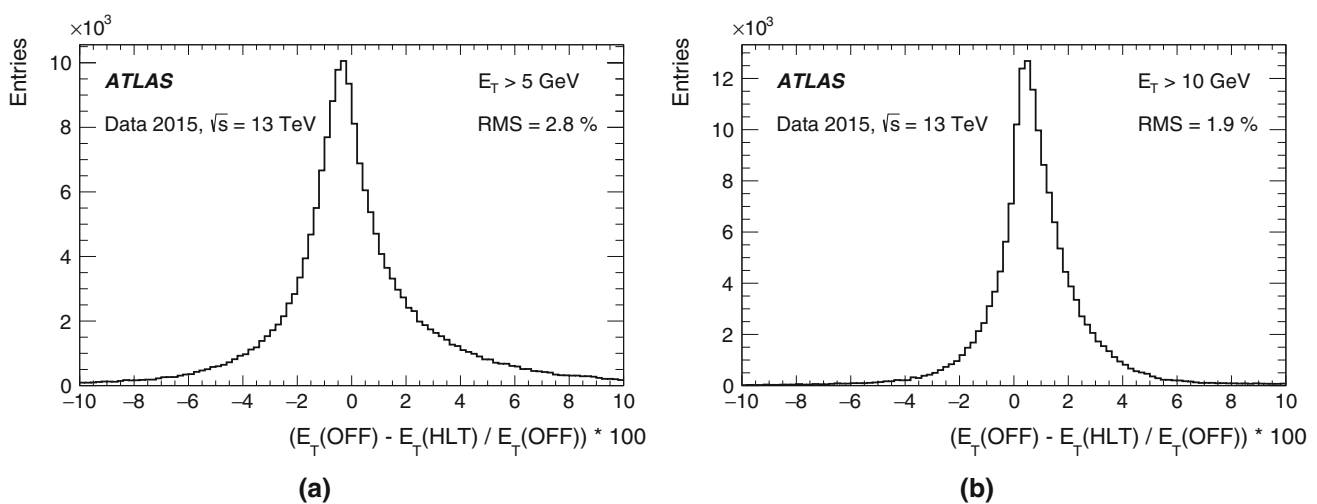

Fig. 17 The relative differences between the online and offline E_T for **a** sliding-window clusters and **b** topo-clusters. Online and offline clusters are matched within $\Delta R < 0.001$. The distribution for the topo-clusters

was obtained from the RoI-based topo-clustering algorithm that is used for online tau reconstruction

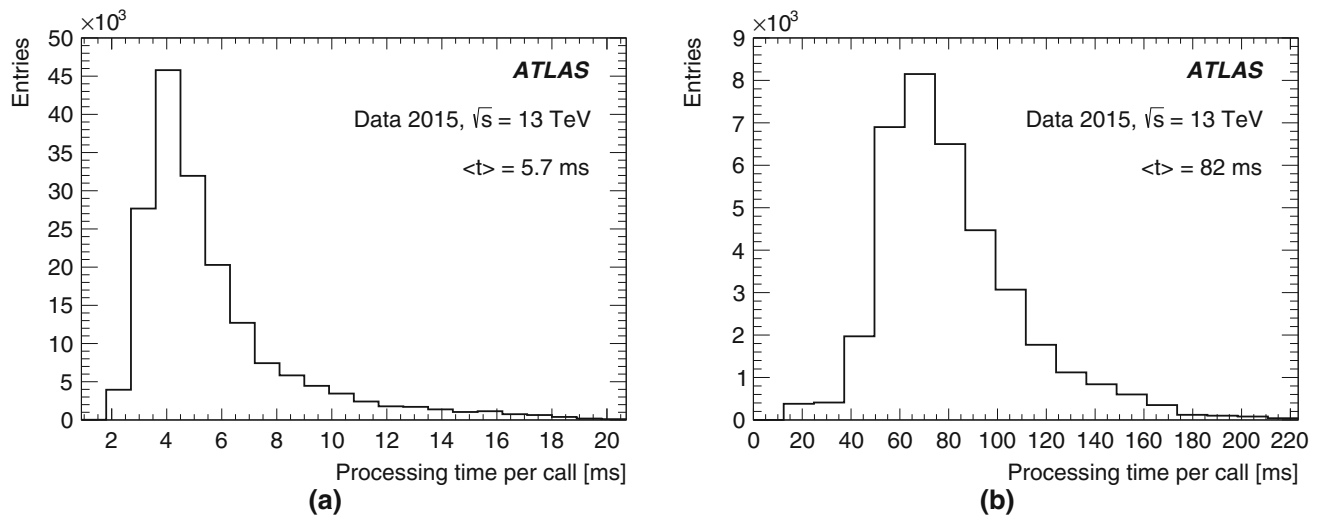

Fig. 18 The distributions of processing times for the topo-clustering algorithm executed **a** within an RoI and **b** on the full calorimeter. The processing times within an RoI are obtained from tau Rols with a size of $\Delta\eta \times \Delta\phi = 0.8 \times 0.8$

5.2.3 Calorimeter algorithm timing

Due to the optimisation of the offline clustering algorithms during LS1, offline clustering algorithms can be used in the HLT directly after the L1 selection. At the data preparation stage, a specially optimised infrastructure with a memory caching mechanism allows very fast unpacking of data, even from the full calorimeter, which comprises approximately 187,000 cells. The mean processing time for the data preparation stage is 2 ms per RoI and 20 ms for the full calorimeter, and both are roughly independent of pile-up. The topo-clustering, however, requires a fixed estimate of the expected pile-up noise (cell energy contributions from pile-up interactions) in order to determine the cluster-building thresholds and, when there is a discrepancy between the expected pile-up noise and the actual pile-up noise, the processing time can show some dependence on the pile-up conditions. The mean processing time for the topo-clustering is 6 ms per RoI and 82 ms for the full calorimeter. The distributions of the topo-clustering processing times are shown in Fig. 18a for an RoI and Fig. 18b for the full calorimeter. The RoI-based topo-clustering can run multiple times if there is more than one RoI per event. The topo-clustering over the full calorimeter runs at most once per event, even if the event satisfied both jet and E_T^{miss} selections at L1. The mean processing time of the sliding window clustering algorithm is not shown but is typically less than 2.5 ms per RoI.

5.3 Tracking in the muon spectrometer

Muons are identified at the L1 trigger by the spatial and temporal coincidence of hits either in the RPC or TGC chambers within the rapidity range of $|\eta| < 2.4$. The degree of

deviation from the hit pattern expected for a muon with infinite momentum is used to estimate the p_T of the muon with six possible thresholds. The HLT receives this information together with the RoI position and makes use of the precision MDT and CSC chambers to further refine the L1 muon candidates.

5.3.1 Muon tracking algorithms

The HLT muon reconstruction is split into *fast* (trigger specific) and *precision* (close to offline) reconstruction stages, which were used during Run 1 at L2 and EF, respectively.

In the fast reconstruction stage, each L1 muon candidate is refined by including the precision data from the MDT chambers in the RoI defined by the L1 candidate. A track fit is performed using the MDT drift times and positions, and a p_T measurement is assigned using lookup tables, creating *MS-only* muon candidates. The MS-only muon track is back-extrapolated to the interaction point using the offline track extrapolator (based on a detailed detector description instead of the lookup-table-based approach used in Run 1) and combined with tracks reconstructed in the ID to form a *combined* muon candidate with refined track parameter resolution.

In the precision reconstruction stage, the muon reconstruction starts from the refined RoIs identified by the fast stage, reconstructing segments and tracks using information from the trigger and precision chambers. As in the fast stage, muon candidates are first formed by using the muon detectors (MS-only) and are subsequently combined with ID tracks leading to combined muons. If no matching ID track can be found, combined muon candidates are searched for by extrapolating ID tracks to the MS. This latter *inside-out* approach is slower

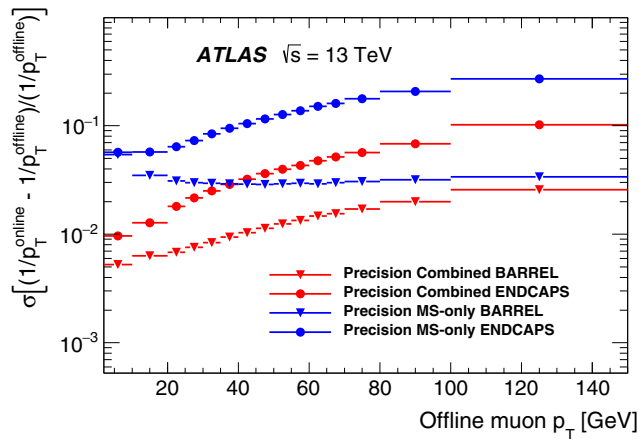

Fig. 19 Width of the residuals for inverse- p_T as a function of offline muon p_T for the precision MS-only and combined algorithms in the barrel ($|\eta| < 1.05$) and end-caps ($1.0 < |\eta| < 2.4$)

and hence only used if the *outside-in* search fails. It recovers about 1–5% of the muons, most of them at low p_T .

The combined muon candidates are used for the majority of the muon triggers. However, MS-only candidates are used for specialised triggers that cannot rely on the existence of an ID track, e.g. triggers for long-lived particles that decay within the ID volume.

5.3.2 Muon tracking performance

Comparisons between online and offline muon track parameters using $Z \rightarrow \mu\mu$ candidate events are presented in this section while muon trigger efficiencies are described in Sect. 6.3. Distributions of the residuals between online and offline track parameters ($1/p_T$, η and ϕ) are constructed in bins of p_T and

two subsequent Gaussian fits are performed on the core of the distribution to extract the widths, σ , of the residual distributions as a function of p_T . The inverse- p_T residual widths, $\sigma((1/p_T^{\text{online}} - 1/p_T^{\text{offline}})/(1/p_T^{\text{offline}}))$, are shown in Fig. 19 as a function of the offline muon p_T for the precision MS-only and precision combined reconstruction. The resolution for combined muons is better than the resolution for MS-only muons due to the higher precision of the ID track measurements, especially at low p_T . As the tracks become closer to straight lines at high p_T , it becomes more difficult to precisely measure the p_T of both the MS and ID tracks, and hence the resolution degrades. The p_T resolution for low- p_T MS-only muons is degraded when muons in the barrel are bent out of the detector before traversing the entire muon spectrometer. The resolution is generally better in the barrel than in the end-caps due to the difference in detector granularity. The η residual widths, $\sigma(\eta^{\text{online}} - \eta^{\text{offline}})$, and ϕ residual widths, $\sigma(\phi^{\text{online}} - \phi^{\text{offline}})$, are shown as a function of p_T in Fig. 20 for both the MS-only and combined algorithms. As the trajectories are straighter at high p_T , the precision of their position improves and so the spatial resolution decreases with p_T . Good agreement between track parameters calculated online and offline is observed.

5.3.3 Muon tracking timing

Figure 21 shows the processing times per RoI for the (a) fast MS-only and fast combined algorithms and (b) precision muon algorithm. The large time difference between the fast and precision algorithms, with the precision reconstruction using too much time to be run by itself at the full L1 muon trigger rate, motivates the need for a two-stage reconstruction.

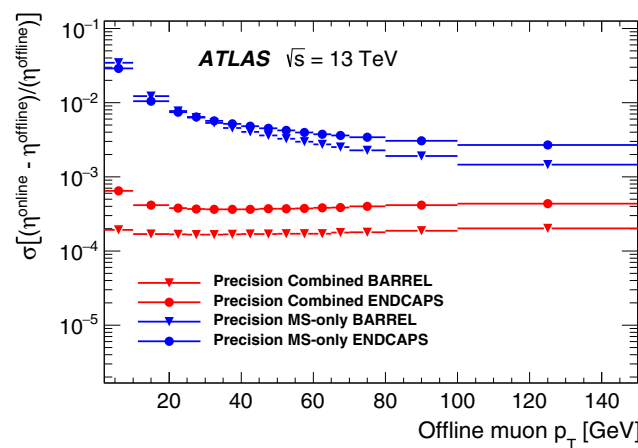

(a)

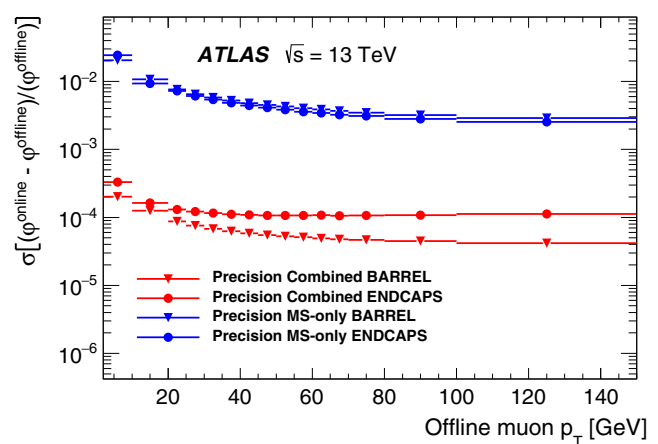

(b)

Fig. 20 Width of the residuals as a function of the offline muon p_T for **a** η and **b** ϕ for the precision MS-only and combined algorithms in the barrel ($|\eta| < 1.05$) and end-caps ($1.0 < |\eta| < 2.4$)

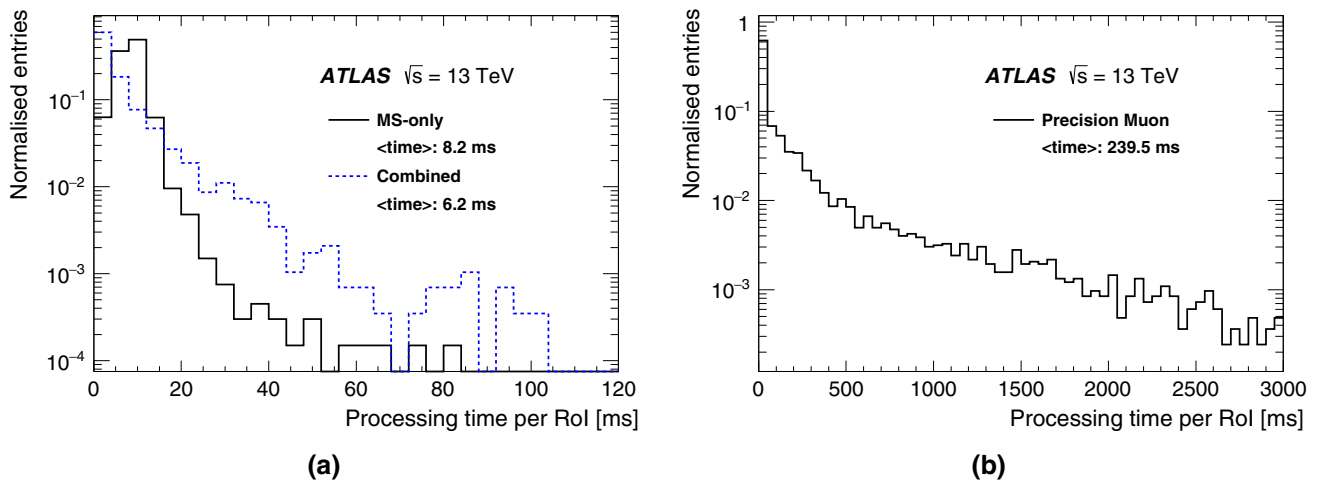

Fig. 21 Processing times per RoI for the **a** fast MS-only and fast combined algorithms and **b** precision muon-finding algorithm. The time for the combined algorithm includes only the time for the ID–MS combi-

nation and not the tracking itself. The mean time of each algorithm is indicated in the legend. The large number of entries in the first bin in **b** is due to algorithm caching [29]

6 Trigger signature performance

The following sections describe the different selection criteria placed upon the reconstructed objects described in Sect. 5 in order to form individual trigger signatures that identify leptons, hadrons, and global event quantities such as E_T^{miss} . For each case the primary triggers used during 2015 are listed together with their output rate and performance. Where possible the trigger efficiency measured in data is compared with MC simulation. The following methods are used to derive an unbiased measurement of the trigger efficiency:

- *Tag-and-probe method*, which uses a sample of offline-selected events that contain a pair of related objects reconstructed offline, such as electrons from a $Z \rightarrow ee$ decay, where one has triggered the event and the other one is used to measure the trigger efficiency;
- *Bootstrap method*, where the efficiency of a higher trigger threshold is determined using events triggered by a lower threshold.

Trigger efficiencies are computed with respect to an offline-selected data sample. The ratio of the measured trigger efficiency to the simulated one is used as a correction factor in physics analyses. Unless otherwise specified, performance studies use good-quality data corresponding to an integrated luminosity of 3.2 fb^{-1} collected during 2015 with a bunch-spacing of 25 ns. Trigger rates shown in the following sections are usually extracted from multiple data-taking runs to cover the maximum range in instantaneous luminosity. Due to different beam and detector conditions between runs, this can result in slightly different trigger rates for nearby luminosity values.

6.1 Minimum-bias and forward triggers

Studies of the total cross-section, hadronisation, diffraction, hadrons containing strange quarks and other non-perturbative properties of pp interactions require the use of a high-efficiency trigger for selecting all inelastic interactions that result in particle production within the detector. The MBTS minimum-bias trigger is highly efficient, even for events containing only two charged particles with $p_T > 100 \text{ MeV}$ and $|\eta| < 2.5$.

The primary minimum-bias and high-multiplicity data set at $\sqrt{s} = 13 \text{ TeV}$ was recorded in June 2015. The average pile-up $\langle \mu \rangle$ varied between 0.003 and 0.03, and the interaction rate had a maximum of about 15 kHz. More than 200 million interactions were recorded during a one-week data-taking period. Most of the readout bandwidth was dedicated to the loosest L1_MBTS_1 trigger (described below) recording events at 1.0 to 1.5 kHz on average.

6.1.1 Reconstruction and selection

The MBTS are used as the primary L1 hardware triggers for recording inelastic events with minimum bias, as reported in Refs. [30,31]. The plastic scintillation counters composing the system were replaced during LS1 and consist of two planes of twelve counters, each plane formed of an inner ring of eight counters and an outer ring of four counters. These rings are sensitive to charged particles in the interval $2.07 < |\eta| < 3.86$. Each counter is connected to a photomultiplier tube and provides a fast trigger via a constant fraction discriminator and is read out through the Tile calorimeter data acquisition system.

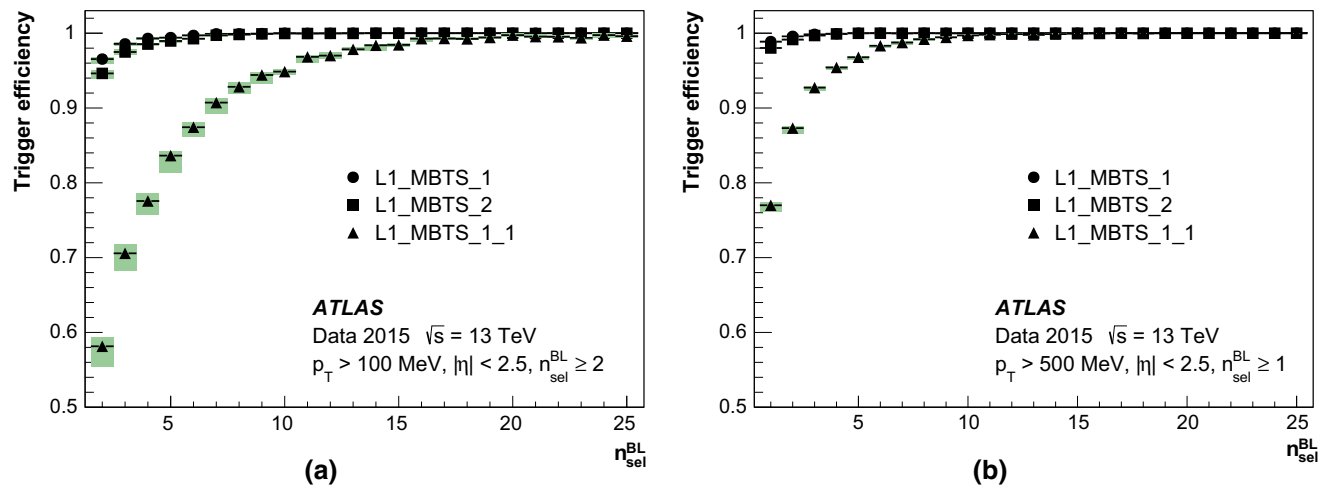

Fig. 22 Efficiency of L1_MBTS_1, L1_MBTS_2 and L1_MBTS_1_1 triggers as a function of the number tracks compatible with the beam line for two different transverse momentum requirements **a** $p_T > 100$ MeV and **b** $p_T > 500$ MeV. The *bands* denote the total uncertainty

The MBTS triggers require a certain multiplicity of counters to be above threshold in a bunch-crossing with colliding beams. The L1_MBTS_1 and L1_MBTS_2 triggers require any one or two of the 24 counters to be above threshold, respectively. The coincidence of two hits in the latter suppresses beam-induced backgrounds from low-energy neutrons and photons. The L1_MBTS_1_1 trigger requires at least one counter to be above threshold in both the $+z$ and $-z$ hemispheres of the detector and is used to seed the high-multiplicity HLT triggers. The same trigger selections are also applied to empty (no beam present) and unpaired (one beam present) beam-crossings to investigate beam-induced backgrounds. No additional HLT selection is applied to L1_MBTS_1 and L1_MBTS_2 triggered events.

The `mb_sptrk` trigger is used to determine the efficiency of the MBTS. It is seeded using a random trigger on filled bunches and requires at least two reconstructed space-points in the Pixel system and three in the SCT, along with at least one reconstructed track with $p_T > 200$ MeV. Studies using MC simulation and a fully unbiased data sample have demonstrated that this control trigger is unbiased with respect to the offline selection.

The primary high-multiplicity trigger (e.g. used in the measurement of two-particle correlations [32]) is `mb_sp900_trk60_hmt_L1MBTS_1_1` and requires at least 900 reconstructed space-points in the SCT and at least 60 reconstructed tracks with $p_T > 400$ MeV. This higher p_T requirement for the high-multiplicity trigger is compatible with the p_T cut used for physics analysis and reduces the computational complexity of the track-finding algorithms in the HLT to an acceptable level.

6.1.2 Trigger efficiencies

The MBTS trigger efficiency is defined as the ratio of events passing MBTS trigger, the control trigger (`mb_sptrk`) and offline selection to events passing the control trigger and offline selection. The efficiency is shown in Fig. 22 for two offline selections as a function of the number of selected tracks compatible in transverse impact parameter ($|d_0| < 1.5$ mm) with the beam line ($n_{\text{sel}}^{\text{BL}}$) for (a) $p_T > 100$ MeV and (b) $p_T > 500$ MeV. The efficiency is close to 95% in the first bin, quickly rising to 100% for L1_MBTS_1 and L1_MBTS_2. The L1_MBTS_1_1 trigger, which requires at least one hit on both sides of the detector, only approaches 100% efficiency for events with around 15 tracks. The primary reason for the lower efficiency of the L1_MBTS_1_1 trigger compared to L1_MBTS_1 or L1_MBTS_2 is that at low multiplicities about 30% of the inelastic events are due to diffractive interactions where usually one proton stays intact and thus particles from the interactions are only produced on one side of the detector. Systematic uncertainties in the trigger efficiency are evaluated by removing the cut on the transverse impact parameter with respect to the beam line from the track selection and applying a longitudinal impact parameter cut with respect to the primary vertex (for events where a primary vertex is reconstructed). This results in a less than 0.1% shift. The difference in response between the two hemispheres is additionally evaluated to be at most 0.12%.

The L1_MBTS_1 trigger is used as the control trigger for the determination of the efficiency turn-on curves for the high-multiplicity data set. The efficiency is parameterised as a function of the number of offline tracks associated with

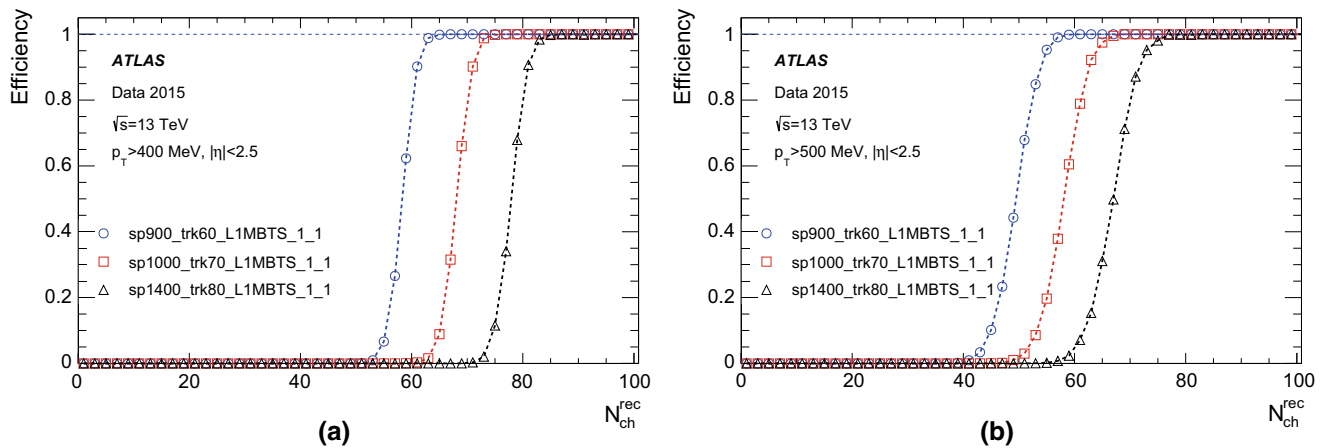

Fig. 23 Efficiency of high-multiplicity triggers as a function of the number of tracks compatible with the primary vertex for two different offline transverse momentum requirements **a** $p_T > 400$ MeV and

b $p_T > 500$ MeV. The curves represent three different selections on the minimum number of SCT space-points and reconstructed tracks (900/60, 1000/70 and 1400/80)

the primary vertex. Figure 23 shows the efficiency for three different selections of the minimum number of SCT space-points and reconstructed tracks and for two selections of the offline track p_T requirement (above 400 and 500 MeV). In the case of matching offline and trigger p_T selections ($p_T > 400$ MeV) shown in Fig. 23a, the triggers are 100% efficient for a value of five tracks above the offline threshold (e.g. `trk60` becomes fully efficient for 65 offline tracks). If the offline requirement is raised to 500 MeV as shown in Fig. 23b, the trigger is 100% efficient for the required number of tracks.

6.2 Electrons and photons

Events with electrons and photons in the final state are important signatures for many ATLAS physics analyses, from SM precision physics, such as Higgs boson, top quark, W and Z boson properties and production rate measurements, to searches for new physics. Various triggers cover the energy range between a few GeV and several TeV. Low- E_T triggers are used to collect data for measuring the properties of $J/\psi \rightarrow ee$, diphoton or low mass Drell–Yan production. Single-electron triggers with E_T above 24 GeV, dielectron triggers with lower thresholds and diphoton triggers are used for the signal selection in a wide variety of ATLAS physics analyses such as studies of the Higgs boson.

6.2.1 Electron and photon reconstruction and selection

At L1 the electron and photon triggers use the algorithms described in Sect. 3.1. The isolation and hadronic leakage veto cuts are not required for EM clusters with transverse energy above 50 GeV.

At the HLT, electron and photon candidates are reconstructed and selected in several steps in order to reject events

as fast as possible, thus allowing algorithms which reproduce closely the offline algorithms and require more CPU time to run at a reduced rate later in the trigger sequence. At first, fast calorimeter algorithms build clusters from the calorimeter cells (covering 0.025×0.025 in $\eta \times \phi$ space) within the RoI ($\Delta\eta \times \Delta\phi = 0.4 \times 0.4$) identified by L1. Since electrons and photons deposit most of their energy in the second layer of the EM calorimeter, this layer is used to find the cell with the largest deposited transverse energy in the RoI. EM calorimeter clusters of size 3×7 in the barrel ($|\eta| < 1.4$) and 5×5 in the end-cap ($1.4 < |\eta| < 2.47$) are used to reconstruct electrons and photons. The identification of electrons and photons is based on the cluster E_T as well as cluster shape parameters such as R_{had} , R_η and E_{ratio} ,³ the latter being used for electron candidates and a few tight photon triggers. Electron candidates are required to have tracks from the fast tracking stage with $p_T > 1$ GeV and to match clusters within $\Delta\eta < 0.2$.

The second step relies on precise offline-like algorithms. The energy of the clusters is calibrated for electron and photon triggers separately using a multivariate technique where the response of the calorimeter layers is corrected in data and simulation [33]. Precision tracks extrapolated to the second layer of the EM calorimeter are required to match to clusters within $\Delta\eta$ of 0.05 and $\Delta\phi$ of 0.05. Electron identification relies on a multivariate technique using a likelihood

³ $R_{\text{had}} = E_{\text{T}}^{\text{had}}/E_{\text{T}}^{\text{EM}}$ is the ratio of the cluster transverse energy in the hadronic calorimeter to that in the EM calorimeter. R_η is based on the cluster shape in the second layer of the EM calorimeter and defined as the ratio of transverse energy in a core region of 3×7 cells in $\eta \times \phi$ to that in a 7×7 region, expanded in η from the 3×7 core. E_{ratio} is defined as the ratio of the energy difference between the largest and second-largest energy deposits in the cluster over the sum of these energies in the front layer of the EM calorimeter.

(LH) discriminant with three operating points named *loose LH*, *medium LH* and *tight LH*. An additional working point named *very loose LH* is used for supporting triggers. The LH-based identification makes use of variables similar to the cut-based identification employed during Run 1 [2] but has better background rejection for the same signal efficiency. The discriminating variables used offline are also used by the trigger, exploiting the characteristic features of energy deposits in the EM calorimeters (longitudinal and lateral shower shapes), track quality, track-cluster matching, and particle identification by the TRT. All variables are described in Refs. [34,35]. The composition of the likelihood is the same as in the offline reconstruction with the exception of momentum loss due to bremsstrahlung, $\Delta p/p$, which is not accounted for in the online environment. The photon identification relies only on the cluster shower-shape variables and three working points are also defined: *loose*, *medium* and *tight*.

Not applied during 2015 but foreseen for higher luminosities during Run 2 is an additional requirement on isolation for the lowest-threshold unprescaled single-electron trigger. The isolation parameter is calculated as the sum of the p_T values of all tracks in a cone of size $\Delta R = 0.2$ around the electron for tracks with $p_T > 1$ GeV and $|\Delta z_0 \sin \theta| < 0.3$, where Δz_0 is the distance along z between the longitudinal impact parameter of the track and the leading track in the RoI. The ratio of this quantity to the EM cluster E_T , namely $\sum p_T/E_T$, is used to estimate the energy deposited by other particles.

6.2.2 Electron and photon trigger menu and rates

The primary L1 and HLT electron and photon triggers used in 2015 are listed in Table 1. The lowest-threshold single-electron trigger ($e24_lhmedium_L1EM20VH$) applies a 24 GeV transverse energy threshold and requires the electron to pass medium LH identification requirements. The trigger is seeded by $L1_EM20VH$, which requires $E_T > 20$ GeV, and applies an E_T -dependent veto against energy deposited in the hadronic calorimeter behind the electromagnetic cluster of the electron candidate (hadronic veto, denoted by H in the trigger name). The E_T threshold varies slightly as a function of η to compensate for passive material in front of the calorimeter (denoted by V in the trigger name). To recover efficiency in the high transverse energy regime, this trigger is complemented by a trigger requiring a transverse energy above 120 GeV with loose LH identification ($e120_lhloose$). With a maximum instantaneous luminosity of $5.2 \times 10^{33} \text{ cm}^{-2} \text{ s}^{-1}$ reached during the 2015 data-taking, the rates of electron triggers could be sustained without the use of additional electromagnetic or track isolation requirements at L1 or HLT. The lowest-threshold dielectron trigger ($2e12_lhloose_L12EM10VH$) applies a 12 GeV transverse energy threshold and requires the two electrons

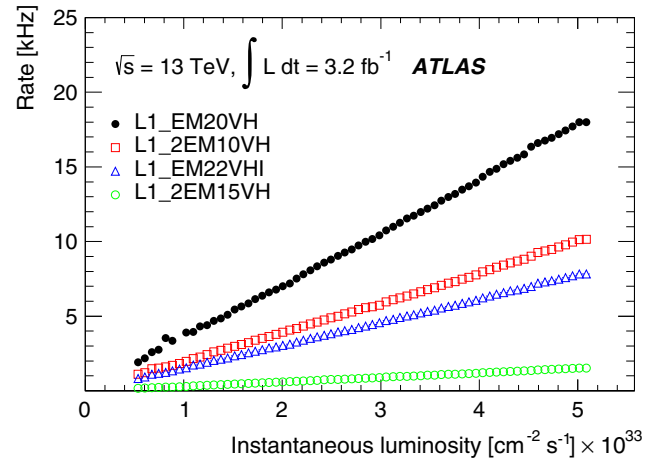

Fig. 24 L1 trigger rates as a function of the instantaneous luminosity for selected single- and multi-object triggers

to pass loose LH identification requirements. The trigger is seeded by $L1_2EM10VH$, which requires two electrons with E_T above 10 GeV and a hadronic energy veto.

The primary single-photon trigger used in 2015 is $g120_lhloose$. It requires a transverse energy above 120 GeV and applies loose photon identification criteria. It is seeded by $L1_EM22VHI$, which requires an isolated electromagnetic cluster (denoted by I in the trigger name) with E_T above 22 GeV and applies a hadronic veto and η -dependent E_T thresholds as described above. As mentioned earlier, the electromagnetic isolation and hadronic veto requirements are not applied for E_T above 50 GeV. The two main diphoton triggers are $g35_lhloose_g25_lhloose$, which requires two photons above 35 and 25 GeV thresholds and loose photon identification requirements, and $2g20_tight$, which requires two photons with E_T above 20 GeV and tight identification. Both triggers are seeded by $L1_2EM15VH$, which requires two electromagnetic clusters with E_T above 15 GeV and a hadronic veto.

Figures 24 and 25 show the rates of the electron and photon triggers as a function of the instantaneous luminosity. These trigger rates scale linearly with the instantaneous luminosity.

6.2.3 Electron and photon trigger efficiencies

The performance of electron triggers is studied using a sample of $Z \rightarrow ee$ events. The tag-and-probe method utilises events triggered by a single-electron trigger and requires two offline reconstructed electrons with an invariant mass between 80 and 100 GeV. After identifying the electron that triggered the event (tag electron), the other electron (probe electron) is unbiased by the trigger selection, thus allowing its use to measure the electron trigger efficiency. HLT electrons (L1 EM objects) are matched to the probe electron if their separation is $\Delta R < 0.07(0.15)$. The trigger efficiency is calcu-

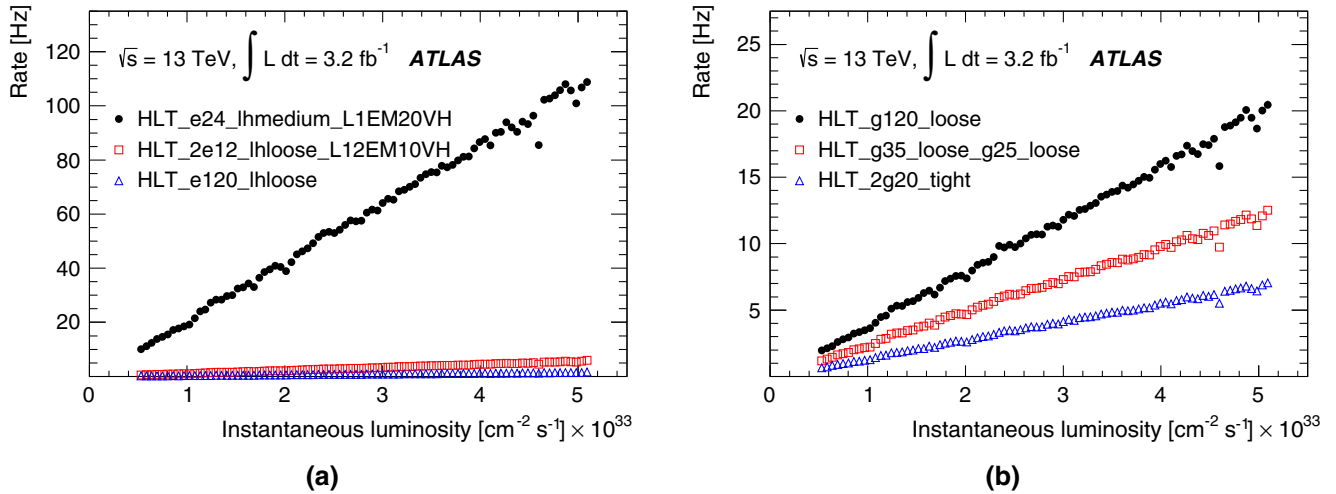

Fig. 25 HLT trigger rates for **a** electron and **b** photon triggers as a function of the instantaneous luminosity for selected single- and multi-object triggers

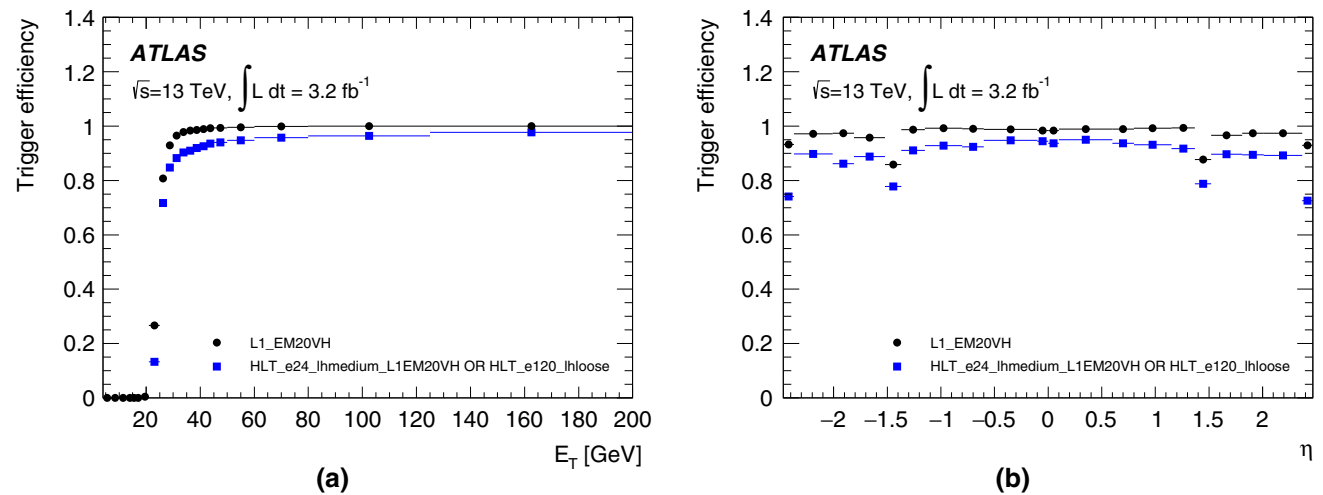

Fig. 26 Efficiency of the L1_EM20VH trigger and the logical ‘or’ of the e24_lhmedium_L1EM20VH and e120_lhloose triggers as a function of **a** the probe electron transverse energy E_T and **b** pseudo-

rapidity η . The offline reconstructed electron candidate is required to have an E_T value at least 1 GeV above the trigger threshold

lated as the ratio of the number of probe electrons passing the trigger selection to the number of probe electrons. The efficiency of the combination of the lowest unrescaled single-electron trigger e24_lhmedium_L1EM20VH and the high transverse momentum electron trigger e120_lhloose with respect to the offline objects is shown in Fig. 26 as a function of the offline reconstructed electron transverse energy and pseudorapidity. The figure also shows the efficiency of the L1 trigger (L1_EM20VH) seeding the lowest unrescaled single-electron trigger. A sharp turn-on can be observed for both the L1 and overall (L1 and HLT) efficiency, and the HLT inefficiency with respect to L1 is small. Inefficiencies observed around pseudorapidities of -1.4 and 1.4 are due to the transition region between the barrel and end-cap calorimeter.

The photon trigger efficiency is computed using the bootstrap method as the efficiency of the HLT trigger relative to a trigger with a lower E_T threshold. Figure 27 shows the efficiency of the main single-photon trigger and the photons of the main diphoton trigger as a function of the offline reconstructed photon transverse energy and pseudorapidity for data and MC simulation. Very good agreement is observed between data and simulation.

6.3 Muons

Muons are produced in many final states of interest to the ATLAS physics programme, from SM precision physics to searches for new physics. Muons are identified with high purity compared to other signatures and cover a wide trans-

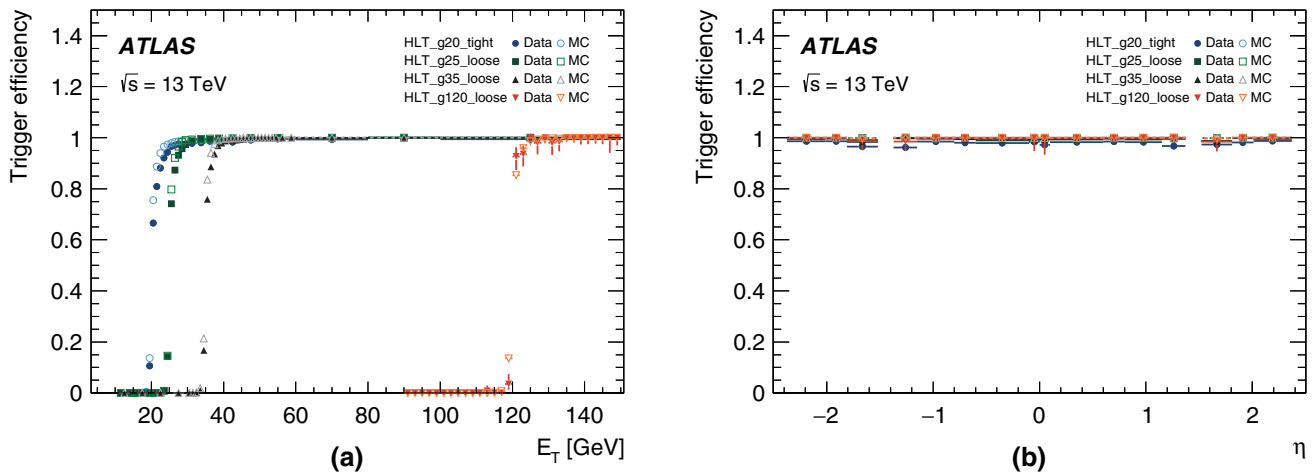

Fig. 27 Efficiency of HLT photon triggers g20_tight, g25_loose, g35_loose, and g120_loose relative to a looser HLT photon trigger as a function of **a** the transverse energy E_T and **b** pseudorapidity η of the photon candidates reconstructed offline and

satisfying the tight identification and isolation requirements. The offline reconstructed photon candidate is required to have an E_T value of at least 5 GeV above the trigger threshold. The transition region between the barrel and end-cap calorimeter ($1.37 < |\eta| < 1.52$) is excluded

verse momentum range, from a few GeV to several TeV. Muon trigger thresholds in the p_T range from 4 to 10 GeV are used to collect data for measurements of processes such as $J/\psi \rightarrow \mu\mu$, low- p_T dimuons, and $Z \rightarrow \tau\tau$ [36,37]. Higher p_T thresholds are used to collect data for new-physics searches as well as measuring the properties and production rates of SM particles such as the Higgs, W and Z bosons, and top quarks [38–40].

6.3.1 Muon reconstruction and selection

The trigger reconstruction algorithms for muons at L1 and the HLT are described in Sects. 3.2 and 5.3, respectively. The selection criteria depend on the algorithm used for reconstruction. The MS-only algorithm selects solely on the p_T of the muon candidate measured by the muon spectrometer; the combined algorithm makes selections based on the match between the ID and MS tracks and their combined p_T ; and the isolated muon algorithm applies selection criteria based on the amount of energy in the isolation cones.

6.3.2 Muon trigger menu and rates

The lowest-threshold single-muon trigger (mu20_loose_L1MU15) requires a minimum transverse momentum of 20 GeV for combined muon candidates in addition to a loose isolation: the scalar sum of the track p_T values in a cone of size $\Delta R = 0.2$ around the muon candidate is required to be smaller than 12% of the muon transverse momentum. The isolation requirement reduces the rate by a factor of approximately 2.5 with a negligible efficiency loss. The trigger is seeded by L1_MU15, which requires a transverse momen-

tum above 15 GeV. At a transverse momentum above 50 GeV this trigger is complemented by a trigger not requiring isolation (mu50), to recover a small efficiency loss in the high transverse momentum region.

The lowest-threshold unprescaled dimuon trigger (2mu10) requires a minimum transverse momentum of 10 GeV for combined muon candidates. The trigger is seeded by L1_2MU10, which requires two muons with transverse momentum above 10 GeV. Figure 28 shows the rates of these triggers as a function of the instantaneous luminosity. The trigger rates scale linearly with the instantaneous luminosity. Dimuon triggers with lower p_T thresholds and further selections (e.g. on the dimuon invariant mass) were also active and are discussed in Sect. 6.8. Additionally, an asymmetric dimuon trigger (mu18_mu8nOL1) is included, where mu18 is seeded by L1_MU15 and mu8nOL1 performs a search for a muon in the full detector at the HLT. By requiring only one muon at L1, the dimuon trigger does not suffer a loss of efficiency that would otherwise have if two muons were required at L1. This trigger is typically used by physics searches involving two relatively high- p_T muons to improve the acceptance with respect to the standard dimuon triggers.

6.3.3 Muon trigger efficiencies

The L1 and HLT muon efficiencies are determined using a tag-and-probe method with $Z \rightarrow \mu\mu$ candidate events. Events are required to contain a pair of reference muons with opposite charge and an invariant mass within 10 GeV of the Z mass. Reference muons reconstructed offline using both ID and MS information are required to be inside the fiducial

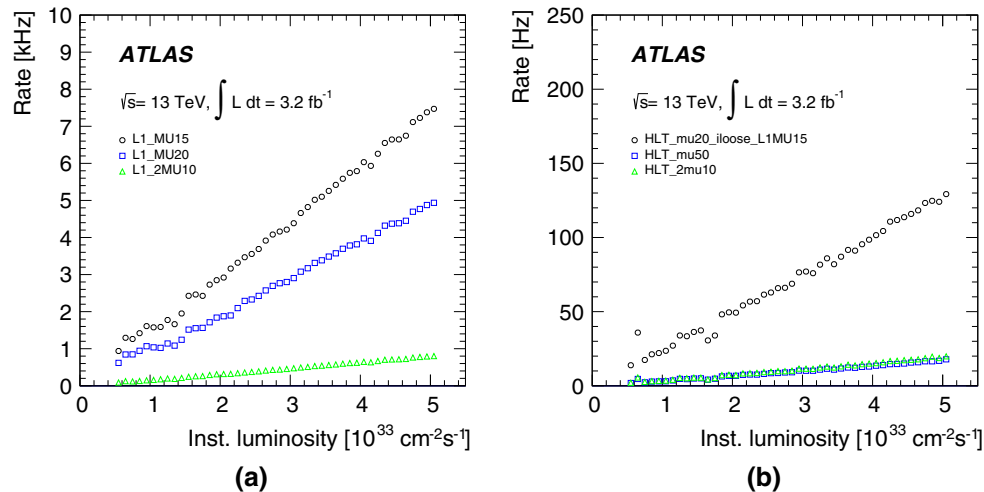

Fig. 28 **a** L1 and **b** HLT muon trigger rates as a function of the instantaneous luminosity for primary single and dimuon triggers

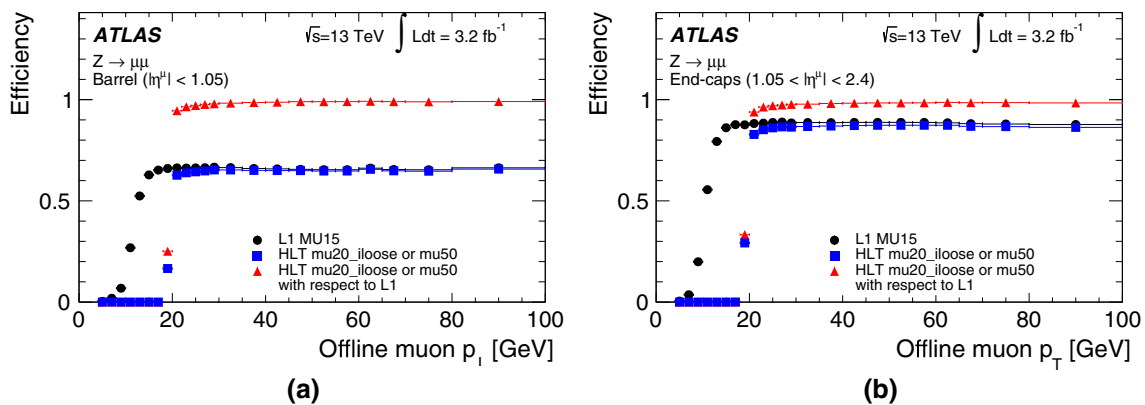

Fig. 29 Efficiency of the L1 muon trigger L1_MU15 and the combination of the HLT muon triggers mu20_loose_L1MU15 and mu50 as a function of the probe muon p_T , separately for **a** the barrel and **b** the end-cap regions

volume of the muon triggers ($|\eta| < 2.4$) and pass the *medium* identification requirements [41, 42].

The absolute efficiency of the L1_MU15 trigger and the absolute and relative efficiencies of the logical ‘or’ of mu20_loose and mu50 as a function of the p_T of the offline muon track are shown in Fig. 29. The L1 muon trigger efficiency is close to 70% in the barrel and 90% in the end-caps. The different efficiencies are due to the different geometrical acceptance of the barrel and end-cap trigger systems and local detector inefficiencies. The HLT efficiency relative to L1 is close to 100% both in the barrel and in the end-caps. Figure 30 shows the muon trigger efficiency as a function of the azimuthal angle ϕ of the offline muon track for (a) the barrel and (b) the end-cap regions. The reduced barrel acceptance can be seen in the eight bins corresponding to the sectors containing the toroid coils and in the two feet sectors around $\phi \approx -1.6$ and $\phi \approx -2.0$, respectively.

6.4 Jets

Jet triggers are used for signal selection in a wide variety of physics measurements and detector performance studies. Precision measurements of inclusive jet, dijet and multi-jet topologies rely on the events selected with the single-jet and multi-jet triggers. Events selected by the single-jet triggers are also used for the calibration of the calorimeter jet energy scale and resolution. All-hadronic decays of $t\bar{t}$ events can be studied using multi-jet signatures and the all-hadronic decay of the weak bosons, Higgs bosons and top quarks can be selected in high transverse momentum (‘boosted’) topologies using large-radius jets. Searches for physics beyond the SM, such as high-mass dijet resonances, supersymmetry or large extra dimensions, often utilise single-jet and multi-jet unpre-scaled triggers with a high transverse momentum threshold.

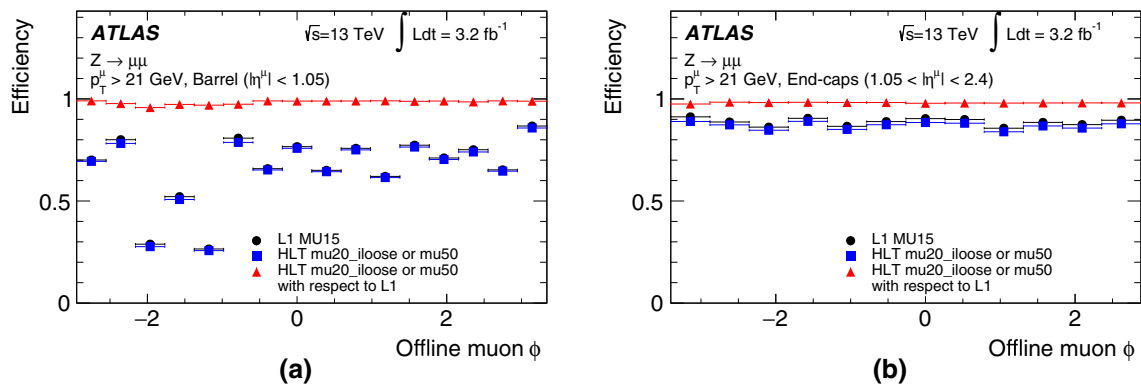

Fig. 30 Efficiency of the L1 muon trigger L1_MU15 and the combination of the HLT muon triggers mu20_loose_L1MU15 and mu50 as a function of the probe muon ϕ , separately for **a** the barrel and **b** the end-cap regions

6.4.1 Jet reconstruction

A detailed description of the jet triggers used during Run 1 can be found in Ref. [5]. Jets are reconstructed in the HLT using the anti- k_r jet algorithm [43] with a radius parameter of $R = 0.4$ or $R = 1.0$. The inputs to the algorithm are calorimeter topo-clusters that are reconstructed from the full set of calorimeter cell information calibrated by default at the EM scale. The jets are calibrated in a procedure similar to that adopted for offline physics analyses [44]. First, contributions to the jet energy from pile-up collisions are subtracted on an event-by-event basis using the calculated area of each jet and the measured energy density within $|\eta| < 2$. Second, the response of the calorimeter is corrected using a series of p_T - and η -dependent calibration factors derived from simulation.

The jet reconstruction in the HLT is highly flexible and some triggers use non-standard inputs or a calibration procedure that differs from the default outlined above. For example, the clusters can be reconstructed using cells from a restricted region in the calorimeter defined using the RoIs identified by the L1 trigger. The clusters can also be calibrated using local calibration weights that are applied after classifying each cluster as electromagnetic or hadronic in origin. Furthermore, the jet calibration can be applied in four ways: no jet calibration, pile-up subtraction only, jet response correction only, or both pile-up subtraction and jet response corrections (default). Finally, the jet reconstruction can be run twice to produce *reclustered* jets [45], in which the input to the second jet-finding is the output from the first, e.g. to build large- R jets from small- R jets.

6.4.2 Jet trigger menu and rates

The jet trigger menu consists of *single-jet* triggers, which require at least one jet above a given transverse energy threshold, *multi-jet* triggers, which require at least N jets above a given transverse energy threshold, H_T triggers, which require

the scalar sum of the transverse energy of all jets in the event, H_T , above a given threshold, and *analysis-specific* triggers for specific topologies of interest. The jet triggers use at L1 either a random trigger (on colliding bunches) or an L1 jet algorithm. The random trigger is typically used for triggers that select events with offline jet $p_T < 45$ GeV to avoid bias due to inefficiencies of the L1 jet algorithm for low- p_T jets. In the following, only the most commonly used jet triggers are discussed.

The lowest-threshold unprescaled single-jet trigger for standard jets ($R = 0.4$) selects events that contain a jet at L1 with transverse energy above 100 GeV (L1_J100) and a jet in the HLT with transverse energy above 360 GeV (j360). This trigger has a rate of 18 Hz at a luminosity of $5 \times 10^{33} \text{ cm}^{-2} \text{ s}^{-1}$. The lowest-threshold unprescaled multi-jet triggers are 3j175, 4j85, 5j60 and 6j45, which have rates of 6, 20, 15 and 12 Hz, respectively. The lowest-threshold unprescaled H_T trigger used in 2015 is h τ 850 with a rate of 12 Hz where one jet with transverse energy above 100 GeV is required at L1 and H_T is required to be above 850 GeV at HLT.

In addition to the unprescaled triggers, a set of lower-threshold triggers select events that contain jets with lower transverse momentum and are typically prescaled to give an event rate of 1 Hz each. The lowest-threshold single-jet trigger in 2015 is j15, which uses a random trigger at L1. Multiple thresholds for single jets exist between j15 and j360 to cover the entire p_T spectrum.

6.4.3 Jet trigger efficiencies

Jet trigger efficiencies are determined using the bootstrap method with respect to the p_T of the jet. The single-jet trigger efficiencies for L1 and the HLT are shown in Fig. 31 for both the central and forward regions of the calorimeter. The ranges in $|\eta|$ are chosen to ensure that the probe jet is fully contained within the $|\eta|$ region of study. Good agreement is observed

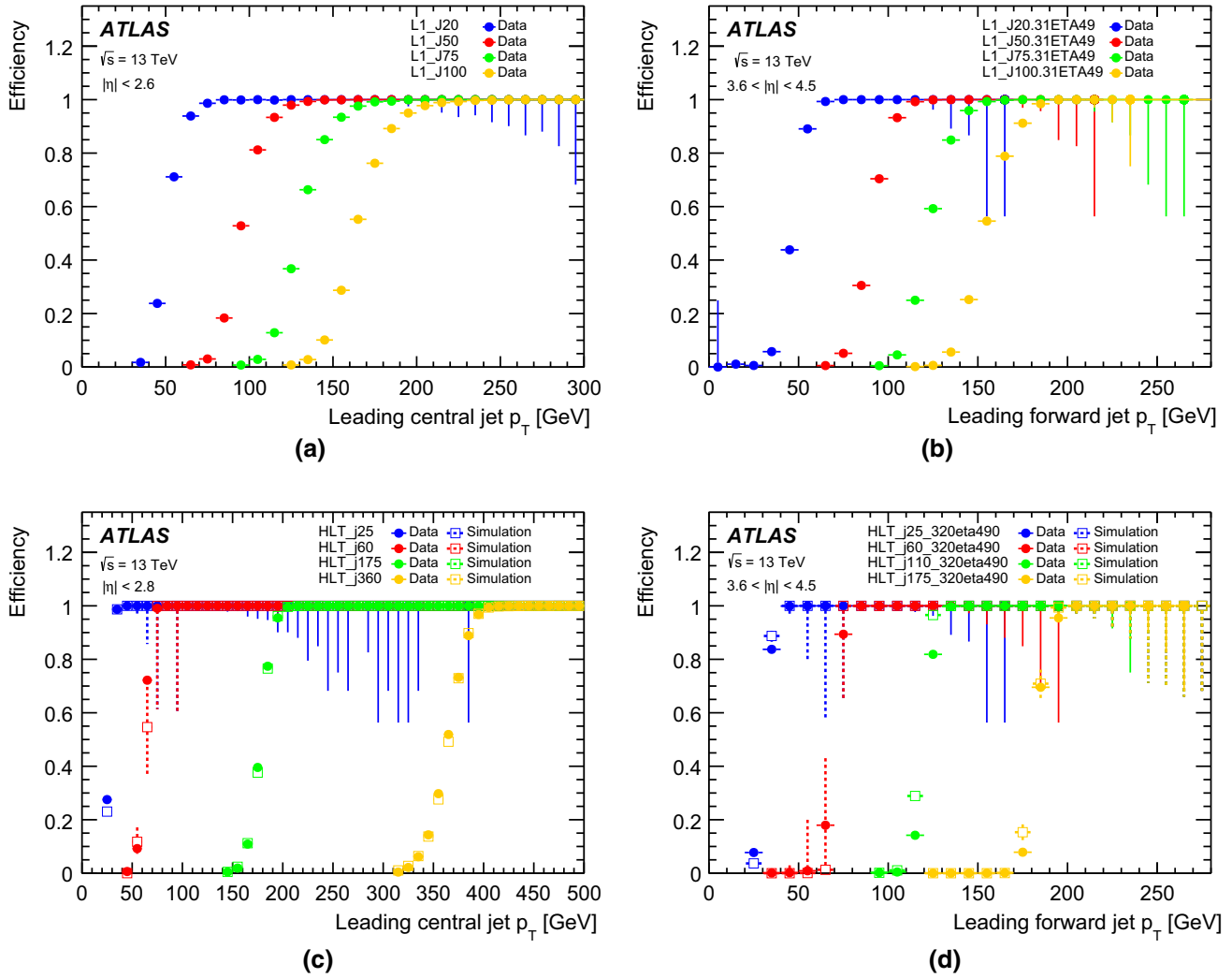

Fig. 31 Efficiency of single-jet triggers as a function of offline jet p_T for **a** L1 in the central region, **b** L1 in the forward region, **c** HLT in the central region, and **d** HLT in the forward region

between simulation and data. The sharp HLT efficiency turn-on curves in Fig. 31 are due to good agreement between the energy scale of jets in the HLT and offline, as shown in Fig. 32.

The multi-jet trigger efficiencies are dominated by the trigger efficiency of the N th leading jet and are shown in Fig. 33 for (a) L1 and (b) HLT as a function of the N th leading jet transverse momentum. Good agreement is found for the efficiency as a function of the N th jet for different jet multiplicities with the same threshold (e.g. L1_6J15, L1_4J15 and 4j45, 5j45) and between data and simulation for the HLT.

Finally, the efficiency of the H_T and large- R ($R = 1.0$) triggers are shown in Fig. 34. The H_T trigger efficiencies are measured with respect to the HLT_j150_L1J40 trigger. There is a small offset in the efficiency curves for data and simulation for both thresholds. For the large- R trig-

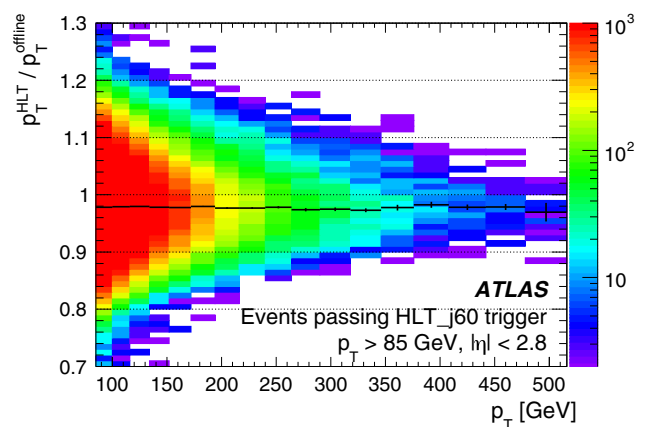

Fig. 32 Comparison between the jet energy scales of trigger and offline jets. The *black points* represent the mean of the distribution at a given p_T value. The 2% shift is due to differences in the jet calibration applied online and offline

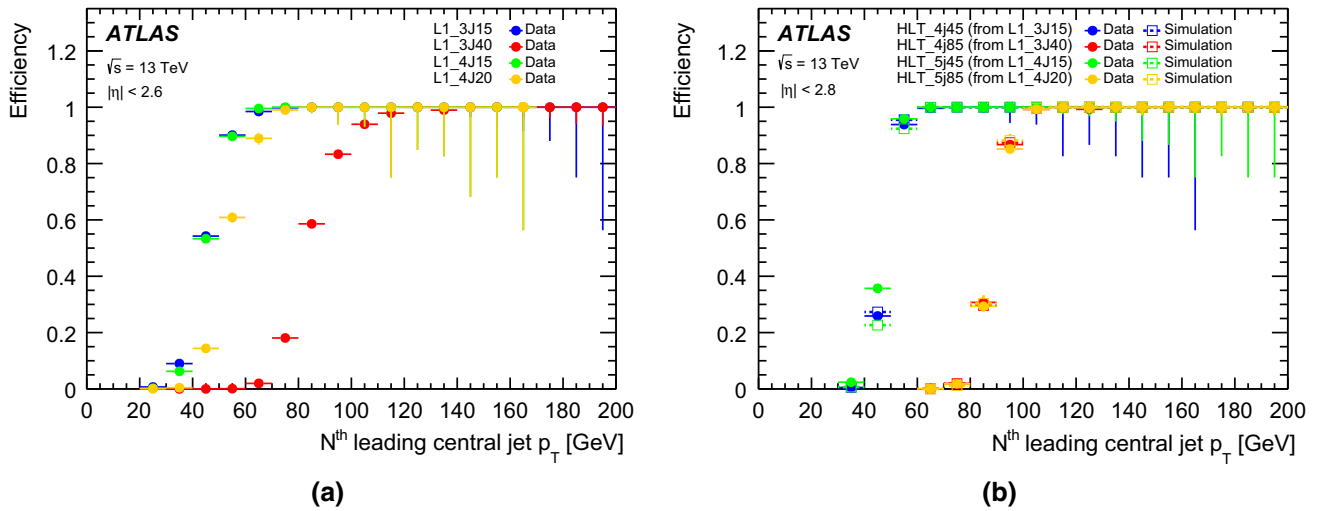

Fig. 33 Efficiency of multi-jet **a** L1 and **b** HLT triggers as a function of offline jet p_T

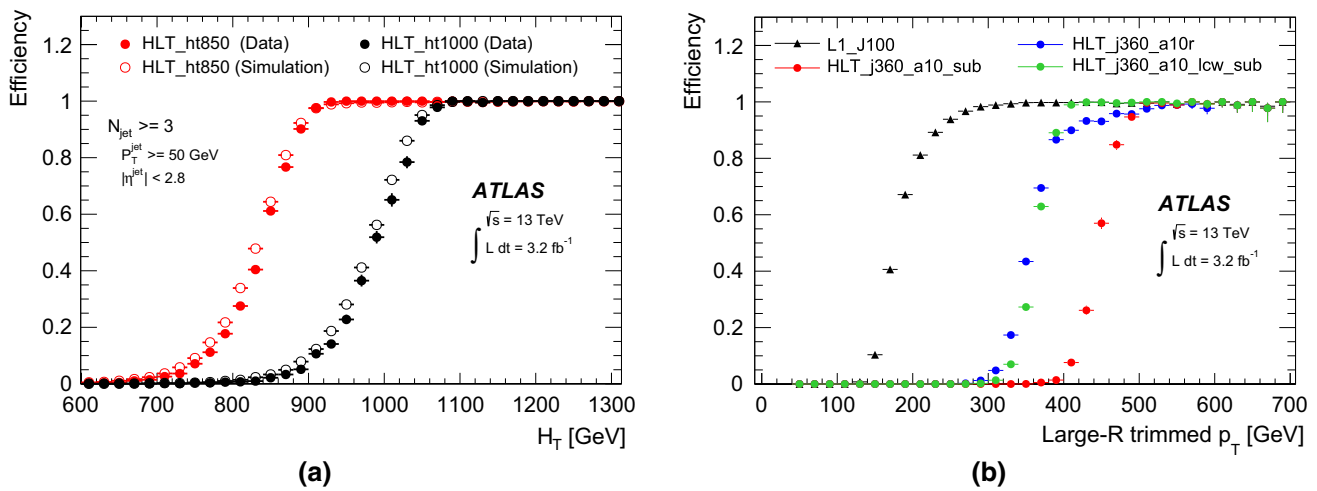

Fig. 34 Efficiency of **a** H_T triggers as a function of offline H_T and **b** large- R ($R = 1.0$) single-jet triggers as a function of offline p_T . H_T is defined as the summed transverse energy of all jets that are reconstructed above a transverse energy threshold of 50 GeV

gers, the HLT threshold is set to 360 GeV and the efficiency curves are shown for three different calibrations and jet input options: jets built from topo-clusters at the EM scale with a pile-up subtraction applied (a10_sub), jets built from topo-clusters with local calibration weights and pile-up subtraction applied (a10_lcw_sub) and reclustered jets built from $R = 0.4$ jets using both pile-up subtraction and local calibration weights (a10r).

6.4.4 Jets and trigger-level analysis

Searches for dijet resonances with sub-TeV masses are statistically limited by the bandwidth allocated to inclusive single-jet triggers. Due to large SM multi-jet backgrounds, these triggers must be prescaled in order to fit within the total physics trigger output rate of 1 kHz. However, as the properties of jets reconstructed at the HLT are comparable to that of

jets reconstructed offline, one can avoid this rate limitation by using Trigger-Level Analysis (TLA) triggers that record partial events, containing only relevant HLT jet objects needed for the search, to a dedicated stream. Using Trigger-Level Analysis triggers allows a factor of 100 increase in the event recording rates, and results in a significant increase in the number of low- p_T jets as shown in Fig. 35. Dedicated calibration and jet identification procedures are applied to these partially built events, accounting for differences between offline jets and trigger jets as well as for the lack of detector data other than from the calorimeters. These procedures are described in detail in Ref. [46].

6.5 Tau leptons

Tau leptons are a key signature in many SM measurements and searches for new physics. The decay into tau lepton pairs

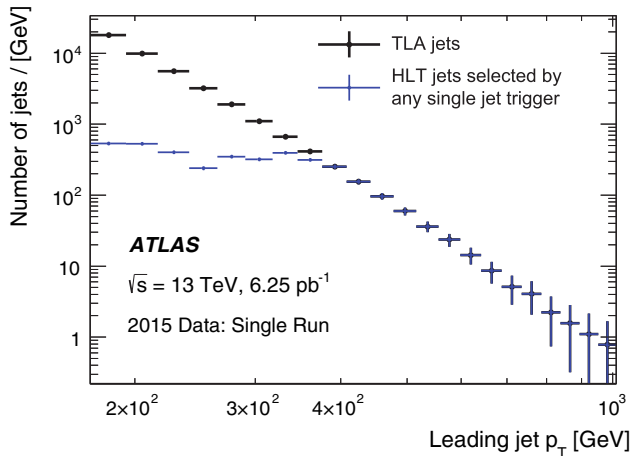

Fig. 35 Jet p_T spectrum after the basic kinematic selection for the TLA trigger jets (black) compared to trigger jets recorded by all single-jet triggers (blue)

provides the strongest signal for measurements of the SM Higgs boson coupling to fermions. Final states containing tau leptons are also often favoured by heavier Higgs bosons or other new resonances in many scenarios beyond the SM. Most (about 65%) of tau leptons decay hadronically. Hence an efficient trigger on hadronic tau decays is crucial for many analyses using tau leptons.

Dedicated tau trigger algorithms were designed and implemented based on the main features of hadronic tau decays: narrow calorimeter energy deposits and a small number of associated tracks. Due to the high production rate of jets with features very similar to hadronic tau decays, keeping the rate of tau triggers under control is particularly challenging.

6.5.1 Tau reconstruction and selection

At L1 the tau trigger uses the algorithms described in Sect. 3.1. The isolation requirement was tuned with 13 TeV simulation to yield an efficiency of 98% and is not applied for tau candidates with a transverse energy above 60 GeV.

At the HLT three sequential selections are made. First, a minimum requirement is applied to the transverse energy of the tau candidate. The energy is calculated using the locally calibrated topo-clusters of calorimeter cells contained in a cone of size $\Delta R = 0.2$ around the L1 tau RoI direction taken from the L1 cluster. A dedicated tau energy calibration scheme is used. Second, two-stage fast tracking (Sect. 5.1.3) is used to select tau candidates with low track multiplicity. A leading track is sought within a narrow cone ($\Delta R = 0.1$) around the tau direction followed by a second fast tracking step using a larger cone ($\Delta R = 0.4$) but with the tracks required to originate from within a fixed interval along the beam line around the leading track. Tracks with $p_T > 1$ GeV are counted in the core cone region $\Delta R < 0.2$ and in the

isolation annulus $0.2 < \Delta R < 0.4$ around the tau candidate direction. A track multiplicity requirement selects tau candidates with $1 \leq N_{\Delta R < 0.2}^{\text{trk}} \leq 3$ and $N_{0.2 < \Delta R < 0.4}^{\text{trk}} \leq 1$. Finally, the HLT precision tracking is run, and a collection of variables built from calorimeter and track variables are input to a Boosted Decision Tree (BDT), which produces a score used for the final tau identification. The implementation of those variables follows closely their offline counterparts as described in Ref. [47]. In addition, the same BDT training is used offline and online to ensure a maximal correlation between online and offline identification criteria. The performance of the offline training was found to be comparable to a dedicated online training. To ensure a robust response under differing pile-up conditions, corrections as a function of the average number of interactions per bunch-crossing are applied to the discriminating variables. Working points of the BDT are tuned separately for 1-prong and 3-prong candidates. The baseline *medium* working point operates with an efficiency of 95% (70%) for true 1-prong (3-prong) taus.

6.5.2 Tau trigger menu and rates

The primary tau triggers consist of triggers for single high transverse momentum taus, and combined $\tau + X$ triggers, where X stands for an electron, muon, a second tau or E_T^{miss} . The transverse momentum thresholds used in the single-tau and ditau triggers in 2015 are indicated in Table 1. For all tau triggers the L1 isolation, HLT track multiplicity and online *medium* identification requirements are applied to the tau candidates.

Due to L1 rate limitations, the combined triggers $\tau + (e, \mu)$ and $\tau + E_T^{\text{miss}}$ require the presence of an additional jet candidate at L1 with transverse momentum above 25 and 20 GeV, respectively. Variants of these triggers with higher thresholds for the tau transverse momentum and without the L1 jet requirement are also included in the trigger menu. Figure 36 shows the L1 and HLT output rates as function of the instantaneous luminosity for the primary single-tau, ditau, $\tau + e$, $\tau + \mu$ and $\tau + E_T^{\text{miss}}$ triggers.

6.5.3 Tau trigger efficiencies

The efficiency of the tau trigger was measured using a tag-and-probe (T&P) method in an enriched sample of $Z \rightarrow \tau_\mu \tau_{\text{had}} \rightarrow \mu + 2\nu + \tau_{\text{had}}$ events, where τ_μ is a tau lepton decaying to $\mu\nu\nu$ and τ_{had} is a tau lepton decaying hadronically. Events are selected by the lowest unpre-scaled single-muon trigger and are tagged by an offline reconstructed and isolated muon with transverse momentum above 22 GeV. The presence of an offline reconstructed tau candidate with transverse momentum above 25 GeV, one or three tracks, fulfilling the *medium* identification criteria and with electric charge opposite to the muon charge is also required. This

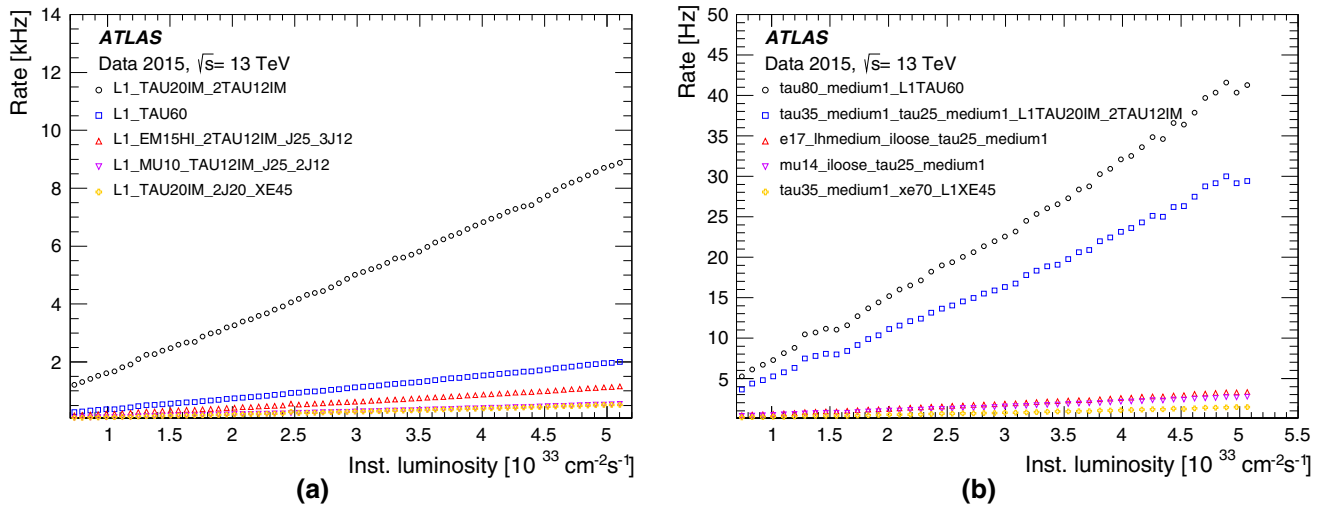

Fig. 36 Trigger rates as a function of instantaneous luminosity for several a L1 and b HLT tau triggers

reconstructed tau candidate is the probe with respect to which the tau trigger efficiency is measured. The event selection used to enhance the sample with $Z \rightarrow \tau_\mu \tau_{\text{had}}$ events and therefore the purity of the probe tau candidate is similar to the one described in Ref. [47]: to reject $Z(\rightarrow \mu\mu) + \text{jets}$ and $W(\rightarrow \mu\nu) + \text{jets}$ events, the invariant mass of the muon and the offline tau candidate is required to be between 45 and 80 GeV, the transverse mass, m_T , composed of the muon p_T and E_T^{miss} ($m_T^2 = 2p_T^\mu E_T^{\text{miss}}(1 - \cos \Delta\phi(\mu, E_T^{\text{miss}}))$) is required to be smaller than 50 GeV, and the variable built from the difference in azimuth between the muon and E_T^{miss} and between the offline tau candidate and E_T^{miss} ($\cos \Delta\phi(\mu, E_T^{\text{miss}}) + \cos \Delta\phi(\tau, E_T^{\text{miss}})$) is required to be above -0.5 . The dominant sources of background events in the resulting sample are $W(\rightarrow \mu\nu) + \text{jets}$ and multi-jet events and their contributions are determined in data as described in Ref. [47]. The multi-jet contribution is estimated from events where the offline tau candidate and the muon have the same electric charge. The $W(\rightarrow \mu\nu) + \text{jets}$ contribution is estimated from events with high m_T .

Distributions of the transverse momentum, pseudorapidity, track multiplicity and BDT discriminant score for the HLT tau candidates matched to the offline probe tau candidates are shown in Fig. 37. The HLT tau candidates pass the tau25_medium trigger, which requires an isolated L1 RoI with transverse momentum above 12 GeV and a tau candidate at the HLT with transverse momentum above 25 GeV satisfying the track multiplicity and the online medium identification criteria. The observed distributions in data are in good agreement with simulation.

The estimated background is subtracted from data and the uncertainty in this subtraction is considered as a systematic uncertainty in the measured efficiency. This systematic uncertainty includes uncertainties in the background contri-

butions estimated from both simulation and data. Figure 38a shows the measured efficiency for the tau25_medium trigger as a function of the transverse momentum of the offline tau candidate. The efficiency loss of the HLT with respect to L1 is mainly due to the HLT's track multiplicity selection and its BDT selection, which uses slightly different input variables online and offline. In Fig. 38b this efficiency is compared with simulation. The statistical uncertainties in data and simulation are shown together with the systematic uncertainties associated with the background subtraction procedure in data.

6.6 Missing transverse momentum

The E_T^{miss} trigger is used in searches where the final state contains only jets and large E_T^{miss} . The E_T^{miss} trigger can also be the most efficient trigger for selecting final states that contain highly energetic muons. An example is searches for supersymmetric particle production where jets, leptons and invisible particles are produced. Another major use is for multi-particle final states where the combination of E_T^{miss} with other trigger objects such as jets, electrons, or photons enables lower thresholds to be used for these other objects than would otherwise be possible. Finally, the E_T^{miss} trigger collects data samples used for detector performance studies. For example, the data set used for electron efficiency calculations in events consistent with a W boson is selected with an E_T^{miss} trigger.

6.6.1 E_T^{miss} reconstruction and selection

The very large rate of hadronic jet production means that, even with reasonably good calorimeter resolution, jet energy mismeasurement can lead to an unaffordably large E_T^{miss} trig-

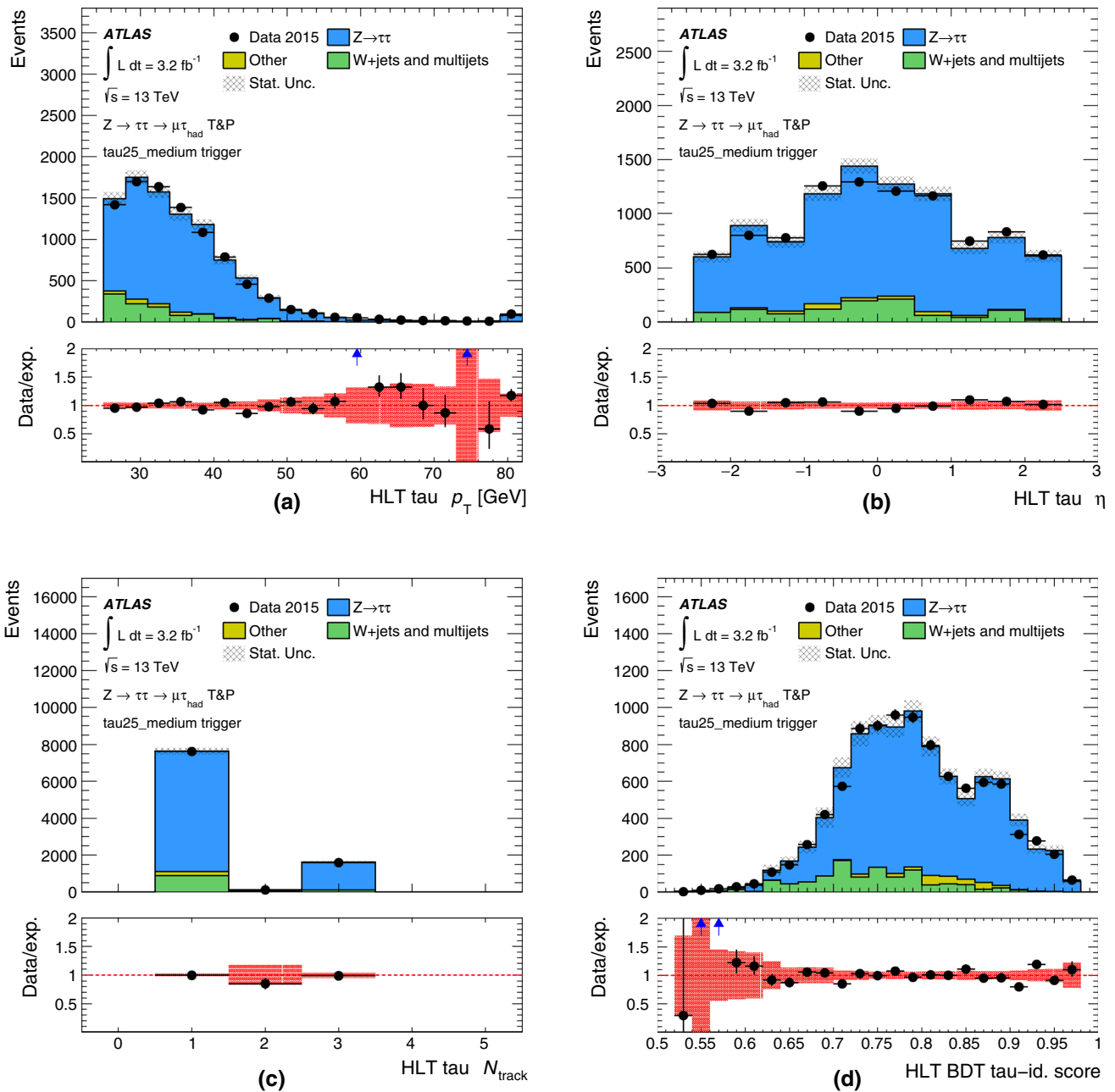

Fig. 37 Distributions of the HLT tau candidates passing the tau25_medium trigger: **a** transverse momentum, **b** pseudorapidity, **c** track multiplicity distributions of the core tracks $\Delta R < 0.2$ of the tau-axis and **d** online BDT identification score. The HLT tau candidates are matched to offline tau candidates with transverse momentum above

25 GeV, with one or three tracks and satisfying the offline *medium* tau identification criterion. Only statistical uncertainties are shown, and the last bin in **a** contains overflow events. The ratio of the observed data to the expected signal and background events is also shown, where the *red band* shows the statistical uncertainty of the total prediction

ger rate. The difficulty is exacerbated by pile-up collisions that add energy to the calorimeter and hence degrade the E_T^{miss} resolution. Controlling the rate via increased trigger thresholds usually reduces the efficiency for analyses.

The improvements in the L1 E_T^{miss} determination, including the L1 dynamic pedestal correction described in Sect. 3.1, have been important in maintaining L1 performance. In par-

ticular they have permitted the L1_XE50 trigger to be used without prescale throughout 2015.

To fulfil the desired broad E_T^{miss} -based physics programme, different HLT algorithmic strategies based on cells, jets or topo-clusters in addition to two methods for correcting the effects of pile-up were developed during LS1 and deployed during 2015 data-taking. While the offline algo-

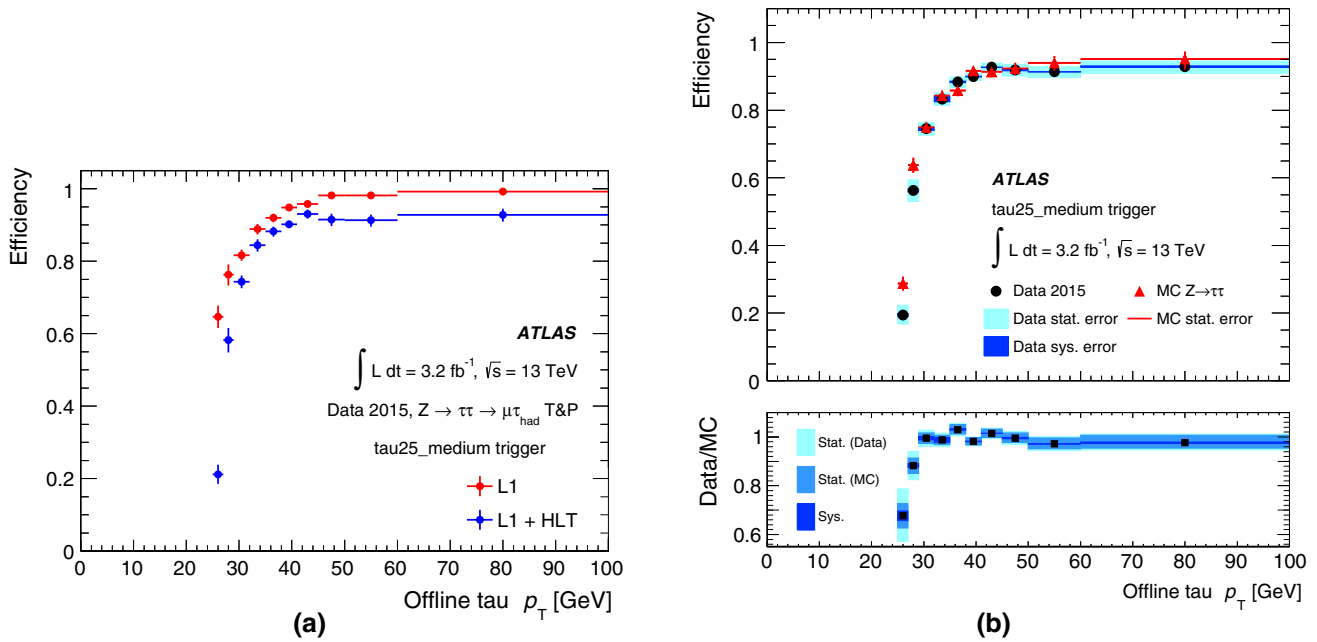

Fig. 38 Efficiency of the tau25_medium trigger measured in data as a function of the offline tau p_T for offline tau candidates with p_T above 25 GeV, one or three tracks and satisfying the offline medium identification requirement. The expected background contribution has been subtracted from the data. **a** Efficiencies after the L1 (red) and

L1+HLT (blue) selections are shown separately with only statistical uncertainties. **b** Comparison of the measured efficiency after L1+HLT to simulation. Statistical uncertainties associated with data and simulation and the systematic uncertainty associated with the background subtraction procedure in data are shown

rithms do often include reconstructed muons in the E_T^{miss} calculation, the trigger algorithms described herein use only energy measurements in the calorimeter. Five different algorithms, involving different levels of complexity (and thus different CPU requirements) were commissioned and evaluated with data during 2015. Since the time-consuming (topo-) clustering is shared between the different algorithms, running them all in parallel does only require a small amount of extra CPU time. The algorithms are as follows:

- **Cell algorithm** (xe): The measured energy in each LAr and Tile calorimeter cell, labelled i , and the position of the cell in the detector are used to obtain the components of the cell measured momentum in the massless approximation, i.e. $p_{x,i} = E_i \sin \theta_i \cos \phi_i$ and $p_{y,i} = E_i \sin \theta_i \sin \phi_i$. To suppress noise and cells with large negative energy, only those cells with energy satisfying $|E_i| > 2\sigma_i$ and $E_i > -5\sigma_i$, are considered further, where σ_i is the noise in the cell energy measurement, including the noise-like effects from pile-up.⁴ Non-functioning calorimeter cells are masked out and do not contribute to the calculation. The total missing transverse momentum two-vector $\vec{p}_T^{\text{miss}} = -\sum_i (p_{x,i}, p_{y,i})$ is found from

the remaining contributing cells, and the E_T^{miss} calculated from its norm $E_T^{\text{miss}} = |\vec{p}_T^{\text{miss}}|$.

- **Jet-based algorithm** (xe_tc_mht): E_T^{miss} is calculated directly from the negative of the transverse momentum vector sum of all jets reconstructed by the jet trigger algorithm presented in Sect. 6.4, which have been corrected for the energy contribution from pile-up.
- **Topo-cluster algorithm** (xe_tc_lcw): Topo-clusters (described in Sect. 5.2.1) are built for the entire calorimeter and used for the E_T^{miss} reconstruction. For each topo-cluster j , the momentum components $(p_{x,j}, p_{y,j})$ are calculated in the approximation that the particles contributing energy to the cluster are massless, and, in a manner similar to the cell algorithm, the missing transverse momentum is calculated from the negative vector sum of these components.
- **Pile-up suppression algorithm** (xe_tc_pueta): This algorithm is based on the topo-cluster E_T^{miss} algorithm described above, but includes a further pile-up suppression method that is intended to limit the degradation of the E_T^{miss} resolution at very high pile-up. The method starts by calculating the average topo-cluster energy and standard deviation in ten regions of pseudorapidity covering, in equal steps, $-5.0 < \eta < 5.0$ in the calorimeter. In each pseudorapidity region, known as a ring, the topo-clusters of energy above 2σ are omitted and the average energy

⁴ A one-sided 2σ noise cut was used during Run 1, which resulted in a bias towards higher E_T^{miss} -values.

of the residual topo-clusters is calculated. This average represents an estimate of the energy contribution from pile-up in that ring. The pile-up energy density in each ring is obtained by dividing the average energy by the solid angle of the ring. This energy density is then multiplied by the solid angle of each topo-cluster and then subtracted from the energy of that topo-cluster to obtain a topo-cluster energy measurement corrected for pile-up. The E_T^{miss} is recalculated as described above using the $(p_{x,j}, p_{y,j})$ of topo-clusters after the pile-up subtraction.

- Pile-up fit algorithm (`xe_tc_pufit`):** Starting again from the topo-cluster E_T^{miss} described above, a different pile-up suppression method is used in this algorithm. The calorimeter is partitioned into 112 towers each of size $\eta \times \phi \approx 0.71 \times 0.79$. For each tower, the p_x and p_y components of all the topo-clusters with centres in that tower are summed to obtain the transverse momentum $\vec{p}_{T,k}$ of that k th tower. The transverse energy sum of the tower $E_{T,k}$ is also calculated from the scalar sum of the p_T of the individual clusters. If $E_{T,k} < 45$ GeV, the tower is determined to be below threshold and its energy assumed to be due to pile-up. The average pile-up E_T density is calculated from $\sum_k E_{T,k} / \sum_k A_k$ of all the towers below threshold, where A_k is the total area in (η, ϕ) coordinates of those towers. A fit estimates the E_T contributed by pile-up in each tower above threshold using the average pile-up E_T density and constraining the event-wide E_T^{miss} from pile-up to be zero within resolution. These estimated pile-up contributions are subtracted from the corresponding E_T measurements for towers above threshold, and these corrected E_T values are used to calculate E_T^{miss} .

Figure 39 shows the E_T^{miss} distribution of the various HLT algorithms for events accepted into the *Main* physics stream. The differences observed between the cell-based and the topo-cluster-based E_T^{miss} distributions are caused in part by different calibration; the cell-based algorithm is calibrated at the EM scale, while algorithms based on topo-clusters generally have larger values of E_T^{miss} as they include a correction for the calorimeter response to hadrons (hadronic scale). Differences between the E_T^{miss} distributions for the various pile-up correction schemes are small, since these algorithms were optimised to improve the resolution at large pile-up values of 80 overlapping interactions that will only be achieved in future LHC runs.

6.6.2 E_T^{miss} trigger menu and rates

All the primary HLT E_T^{miss} algorithms used in 2015 were seeded by the `L1_XE50` trigger with a nominal threshold, calibrated at the EM scale, of 50 GeV. The `L1_XE50` output rate was approximately 700 Hz at an instantaneous luminosity of $5 \times 10^{33} \text{ cm}^{-2} \text{ s}^{-1}$ as shown in Fig. 40a. The HLT

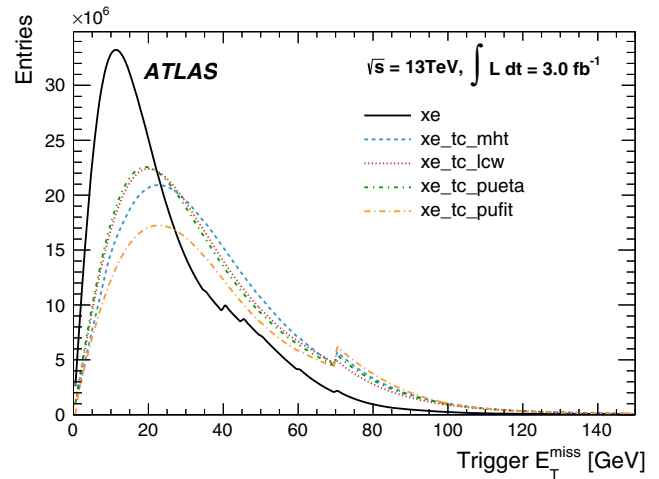

Fig. 39 Comparison of the different E_T^{miss} distributions for events accepted by the HLT into the *Main* physics stream. The algorithms consist of a cell-based E_T^{miss} (`xe`) and different topo-cluster-based algorithms described in the text. The zero entries of the `xe_tc_pufit` algorithm, which occur when no tower is above threshold, have been suppressed. The steps in the distributions are caused by the various trigger thresholds

`xe` trigger with a threshold of 70 GeV remained unprescaled throughout the 2015 data-taking period. The typical output rate for this trigger was approximately 50 Hz at the same luminosity as seen in Fig. 40b. The topo-cluster-based algorithms, all of which are calibrated at the hadronic scale, had rates of approximately 110 Hz at the equivalent nominal threshold of 70 GeV. The output rate from these algorithms is larger for the same nominal threshold due in part to the different calibration methods. Prescaled triggers at a set of lower L1 and HLT thresholds, with HLT output rates of order 1 Hz each, were included in the menu to record a sample of data from which the efficiency of the unprescaled, primary physics triggers could be calculated. Further triggers based on the significance of the observed E_T^{miss} , known as `xs` triggers [48] were used to select $W \rightarrow e\nu$ events for electron reconstruction performance studies. Triggers used during Run 1 for selecting events based on the scalar sum of the transverse energy of all calorimeter cells ΣE_T were found to have a high sensitivity to pile-up [48], and so were not used during the proton–proton run in 2016.⁵

6.6.3 E_T^{miss} trigger efficiencies

Since E_T^{miss} is a global observable calculated from many contributions, each of which has its own detector resolution, the efficiency of the E_T^{miss} trigger for any particular analysis inevitably depends on the event selection used in that analysis. The efficiency turn-on curves of the various E_T^{miss} trigger

⁵ A ΣE_T trigger was used during heavy-ion collisions at L1.

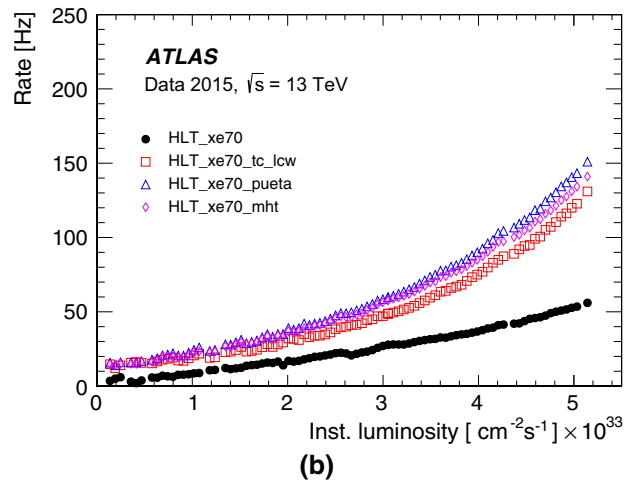
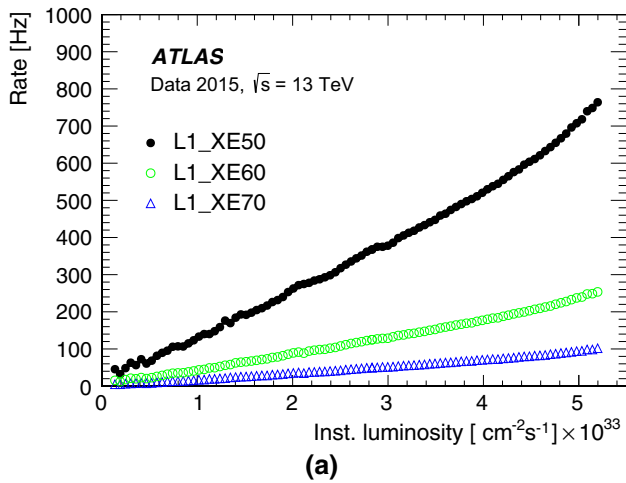

Fig. 40 E_T^{miss} trigger rates (a) at L1 and (b) for various HLT algorithms operating with nominal thresholds of 70 GeV. The HLT algorithms are each seeded by L1_XE50. Rates are shown as a function of instantaneous

luminosity from various runs taken in 2015 excluding periods with atypically high or low rates arising from different pile-up conditions for the same instantaneous luminosity

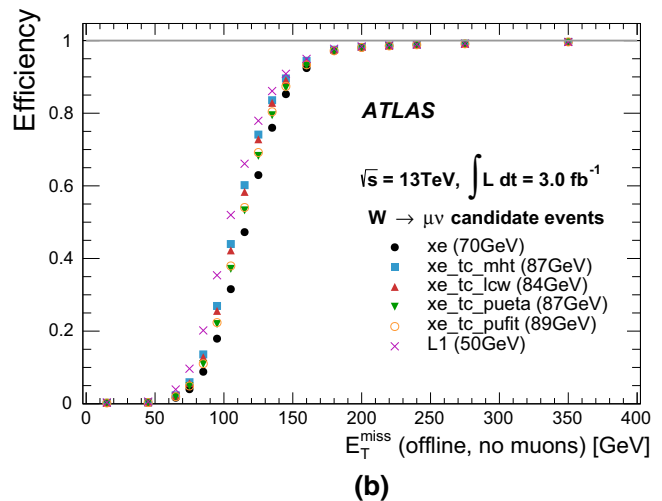
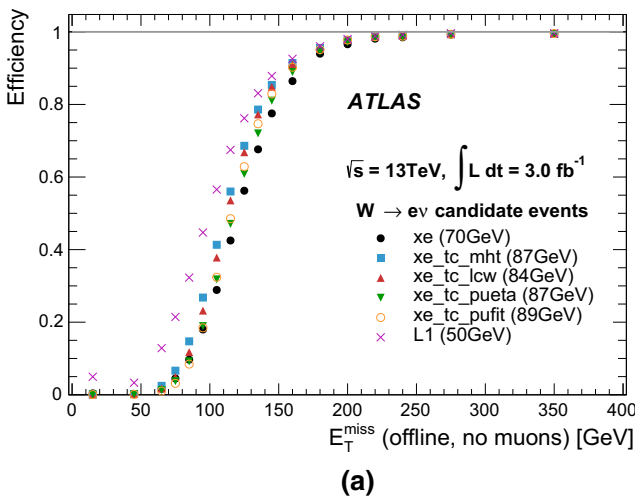

Fig. 41 E_T^{miss} trigger efficiency curves with respect to the E_T^{miss} reconstructed offline without muon corrections for all events passing the a $W \rightarrow e\nu$ or b $W \rightarrow \mu\nu$ selections. The different efficiencies were mea-

sured for L1, and for the combination of L1 with each of the HLT E_T^{miss} algorithms. The thresholds for the different algorithms correspond to an approximately equal trigger rate

algorithms are shown in Fig. 41, for $W \rightarrow e\nu$ and $W \rightarrow \mu\nu$ selections. The selection is similar to that of the W boson cross-section measurement [39], requiring exactly one lepton (electron or muon) with $p_T > 25$ GeV, transverse mass $m_T > 50$ GeV, and a single lepton trigger (24 GeV single-electron or 20 GeV single-muon). The efficiencies are shown as a function of a modified offline E_T^{miss} calculation with no muon correction, emulating the calorimeter-only E_T^{miss} calculation used in the trigger. The event kinematics for the same E_T^{miss} are very different for the decays into electron and muon, since the energy of the electron for $W \rightarrow e\nu$ is included in both the online and offline calculations of E_T^{miss} , whereas this is not the case for the muon in $W \rightarrow \mu\nu$.

Events with high p_T muons are recorded by the muon triggers.

The turn-on curves are shown for different nominal HLT E_T^{miss} thresholds, selected such that they give rates close to that of the x_e algorithm at its lowest unprescaled (70 GeV) threshold. All the HLT algorithms, with their stated thresholds, are close to fully efficient with respect to the offline E_T^{miss} for values of $E_T^{\text{miss}} > 200$ GeV. At that value of E_T^{miss} , the L1_XE50 trigger itself has an efficiency in the range of 95–99%, depending on the exact event selection required. The topo-cluster-based algorithms, and in particular $x_{e_tc_mht}$ have higher efficiency in the turn-on region than the cell-based algorithm.

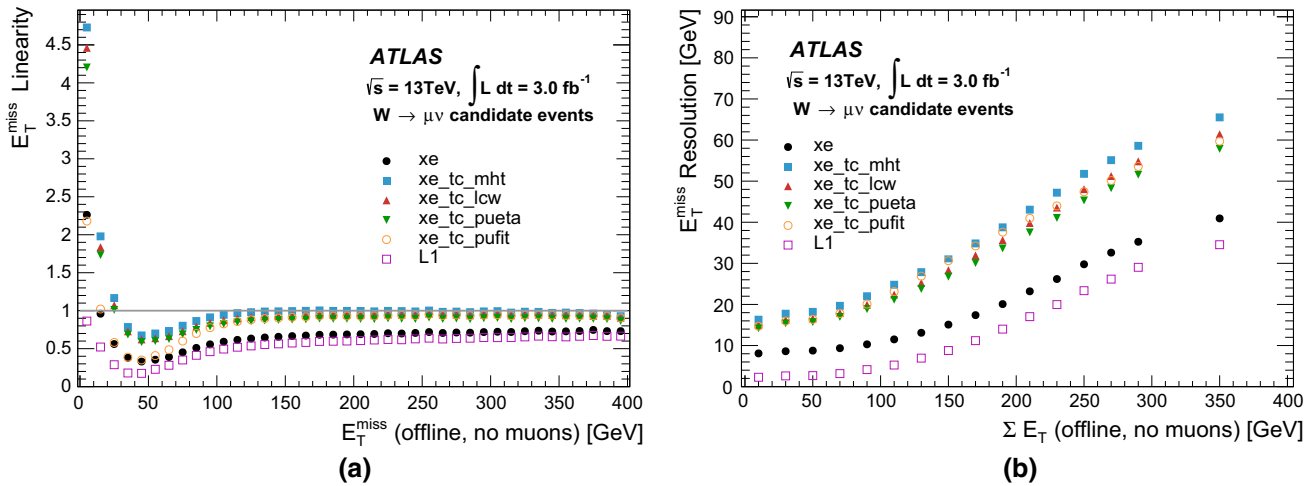

Fig. 42 **a** E_T^{miss} trigger linearity with respect to the E_T^{miss} reconstructed offline without muon corrections and **b** E_T^{miss} trigger resolution with respect to the ΣE_T reconstructed offline without muon corrections, for

all events passing $W \rightarrow \mu\nu$ selections for L1 and for each HLT E_T^{miss} algorithm. Linearity and resolution are defined in the text

The linearity of the E_T^{miss} trigger is defined as the average ratio of the trigger E_T^{miss} to the offline E_T^{miss} . The linearity of the L1 algorithm and the various HLT algorithms is shown in Fig. 42a. For the larger values of offline E_T^{miss} where the triggers approach full efficiency, the topo-cluster-based HLT algorithms show good linearity at values close to unity. The L1 and the x_e HLT algorithms also show stable linearity in the trigger efficiency plateau, but at a lower value, reflecting their calibration at the EM scale rather than the hadronic scale.

The E_T^{miss} resolution is defined as the RMS of the x -component of the core of the \vec{p}_T^{miss} distribution. Since the resolution is dominated by the stochastic fluctuations in calorimeter energy measurements, it is shown in Fig. 42b as a function of the offline value of ΣE_T (reconstructed offline without muon corrections). The expected approximate scaling of E_T^{miss} with $\sqrt{\Sigma E_T}$ can be observed. The stochastic contribution to the resolution can be seen to be accompanied by an offset that varies from algorithm to algorithm and that is lower in the cell-based, electromagnetically calibrated L1 and x_e algorithms. Such differences are expected because different noise suppression schemes are used to define calorimeter cells and topological clusters.

Figure 43 shows the efficiency of the trigger-level E_T^{miss} algorithm for $W \rightarrow \mu\nu$ events for several ranges of the number of reconstructed vertices. The effect of pile-up on the E_T^{miss} turn-on curves can be seen in this figure for the topo-cluster algorithm ($x_e\text{-tc_lcw}$), which does not employ any pile-up correction methods. Some degradation of efficiency is observed for larger numbers of proton–proton vertices N_{vtx} . The larger pile-up both increases the trigger rate, through increasing the probability to pass the trigger at lower E_T^{miss} , and degrades the efficiency in the turn-on region.

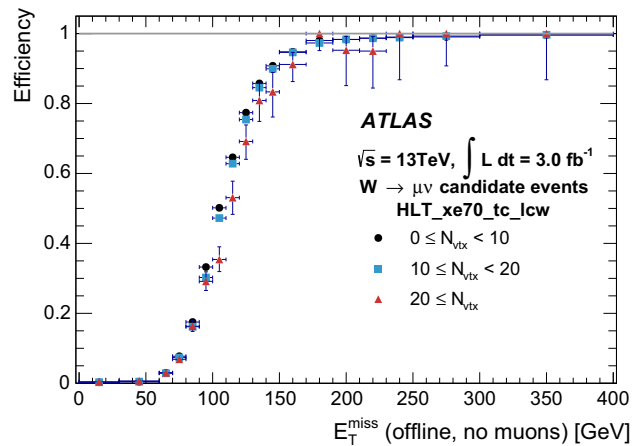

Fig. 43 E_T^{miss} trigger efficiency curves with respect to the E_T^{miss} reconstructed offline without muon corrections for the $W \rightarrow \mu\nu$ selection. The different efficiencies were obtained for different pile-up conditions expressed in terms of various ranges of the average number of reconstructed vertices per bunch-crossing (denoted here as N_{vtx}). The efficiency of the L1 algorithm is included

6.7 b -Jets

Bottom-quark-initiated jet (b -jet) triggers are designed to identify heavy-flavour content in real time and provide the means to efficiently record events with fully hadronic final states containing b -jets. Various signatures from the Higgs boson or physics beyond the SM rely on triggering on b -jets. These include the SM processes $t\bar{t}H(H \rightarrow b\bar{b})$ and vector-boson fusion production with $H \rightarrow b\bar{b}$, the supersymmetric decay $bA \rightarrow b\bar{b}$, search for di- b -jet resonances, and resonant and non-resonant Higgs boson pair production $HH \rightarrow b\bar{b}b\bar{b}$.

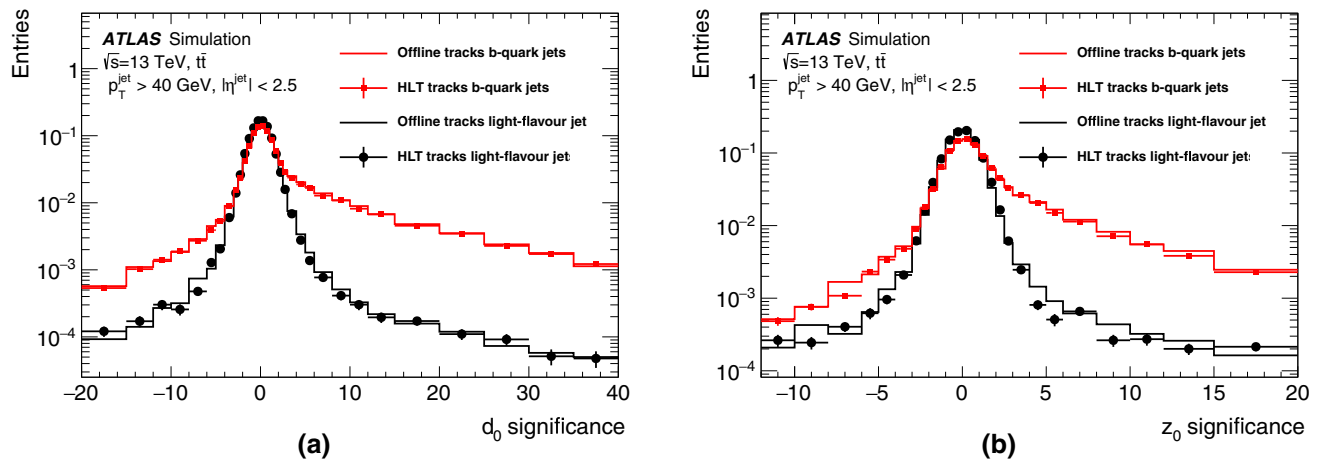

Fig. 44 **a** Transverse and **b** longitudinal impact parameter significance for tracks associated with light-flavour (black) and b -quark (red) jets measured in a sample of simulated $t\bar{t}$ events. The solid lines show the distribution for the offline tracks. The points show the corresponding distribution for tracks used in the b -jet trigger. The impact parameter

significance is defined as the impact parameter divided by the associated uncertainty. The impact parameters are signed such that track displacements in the direction of the jet have positive values, while tracks with displacements opposite of the jet direction are negative

6.7.1 b -Jet reconstruction and selection

Several b -hadron properties are exploited to identify (tag) b -jets. The b -hadrons have a mean lifetime of ~ 1.5 ps and often travel several millimetres before decaying. Consequently, a secondary vertex (SV) displaced from a primary interaction point characterises the decay. Reconstructed tracks associated with this SV have large transverse and longitudinal (z_0) impact parameters with respect to the primary vertex. In addition, b -hadrons go through hard fragmentation and have a relatively high mass of about 5 GeV. Thus, in addition to the decay length, b -jets can be distinguished from light-quark jets by having a large invariant mass, a large fraction of jet energy carried by tracks and a large track multiplicity.

As track and vertex reconstruction are crucial for the identification of b -jets, the b -jet trigger relies heavily on the performance of the ID tracking described in Sect. 5.1. Several improvements in the ID tracking made for Run 2 have directly benefited the b -jet trigger. The new IBL improves the impact parameter resolution of reconstructed tracks, leading to better b -jet identification and overall performance of the b -jet triggers [7]. Another improvement for Run 2 is the multiple-stage tracking described in Sect. 5.1.3. This new approach provides improved primary vertex finding and mitigates CPU requirements in the face of increased pile-up.

The basic inputs to b -tagging are reconstructed jets, reconstructed tracks and the position of the primary vertex. The jet reconstruction used in the trigger is described in Sect. 6.4.1. The b -jet trigger uses tracks from the precision stage of the ID trigger reconstruction. The beam-spot location is used for the position of the primary vertex in the plane transverse to the beam line. Dedicated algorithms are run online to recon-

struct and monitor the position of the beam spot in real time. The position of the primary vertex along the beam line is taken from the z position of the primary vertex reconstructed as described in Sect. 5.1.3. Distributions of the transverse and longitudinal impact parameter significances for light-flavour and b -quark jets are shown in Fig. 44 for a sample of simulated $t\bar{t}$ events. Tracks used in the online b -tagging are compared to the corresponding tracks used offline.

During Run 1, the b -jet triggers used a combination of two likelihood-based algorithms, IP3D and SV1 [49]. The IP3D algorithm discriminates between b - and light-jets using the two-dimensional distribution of the longitudinal and transverse impact parameter significances. The SV1 algorithm exploits properties of the secondary vertex such as the invariant mass of tracks matched to the vertex, the fraction of the jet energy associated with the secondary vertex and the number of two-track vertices. These Run 1 algorithms, optimised for Run 2 conditions, were used during 2015 data-taking. Three operating points, *loose*, *medium* and *tight*, are defined to correspond to b -jet identification efficiencies obtained from simulated $t\bar{t}$ events of 79, 72 and 62%, respectively.

Another major development in the b -jet trigger for Run 2 is the adaptation of the offline b -tagging algorithms [50] for use in the trigger. The use of the offline MV2 multivariate b -tagging algorithm provides better online b -jet identification and leads to a higher level of coherence between the online and offline b -tagging decisions. The MV2 algorithm uses inputs from the IP3D, SV1 and JetFitter algorithms. The JetFitter algorithm exploits the topological structure of weak b - and c -hadron decays inside the jet. The MV2 algorithm used in the trigger was optimised to identify b -jets using a training sample with a background composition of 80%

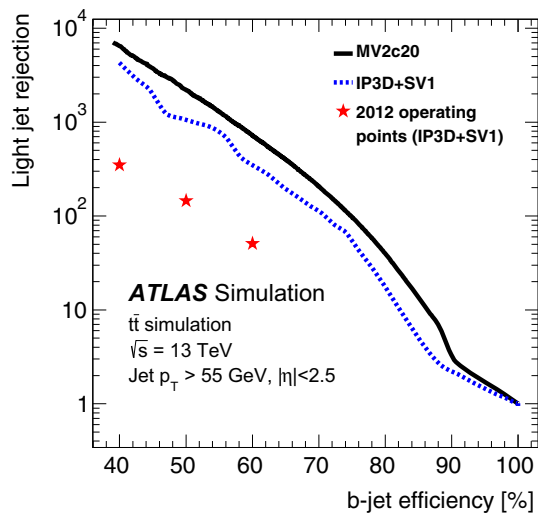

Fig. 45 The expected performance of the MV2c20 trigger tagger (*solid black line*) in terms of light-jet rejection is shown together with the expected performance of the IP3D+SV1 trigger tagger in Run 2 (*dashed blue line*) and its actual performance achieved during Run 1 (*red stars*)

(20%) light- (*c*-) jets and is referred to as MV2c20. Operating points analogous to *loose*, *medium* and *tight* were defined for MV2c20 and give light-flavour rejections similar to the corresponding operating points of the Run 1 *b*-tagging algorithm. Triggers utilising the MV2c20 *b*-tagging algorithm were run in 2015 for commissioning purposes. MV2c20 is the baseline *b*-tagging algorithm for 2016. Figure 45 shows the expected performance of the MV2c20 and the IP3D+SV1 trigger taggers in Run 2 compared to the actual performance of the IP3D+SV1 tagger that was achieved during Run 1.

Figure 46 shows the efficiency of the online *b*-tagging as a function of jet p_T for the three operating points. The efficiencies are calculated in a pure sample of *b*-jets from fully leptonic $t\bar{t}$ decays and are computed with respect to jets identified by the 70% working point of the MV2c20 algorithm. Events used in the efficiency calculation require an online jet with p_T greater than 40 GeV. A significant gain in trigger efficiency is seen when moving to the MV2 *b*-tagging algorithms.

6.7.2 *b*-Jet trigger menu and rates

Several *b*-jet triggers have been implemented with different combinations of jets and *b*-tagged jets, using different p_T thresholds and *b*-tagging operating points. The operating points, thresholds and multiplicities, for several of the primary *b*-jet triggers are listed in Table 1. The jet multiplicities vary between one and four, with up to two *b*-tagged jets. The *b*-jet triggers are typically seeded at L1 using either a single jet with $E_T > 100$ GeV or three jets with $E_T > 25$ GeV and pseudorapidity $|\eta| < 2.5$. Rates of various *b*-jet triggers as a function of luminosity are shown in Fig. 47.

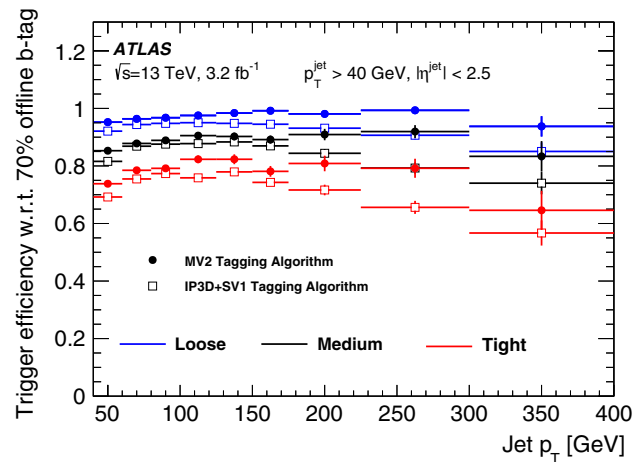

Fig. 46 *b*-jet trigger efficiency as a function of jet p_T for the loose (*blue*), medium (*black*) and tight (*red*) operating points. The *open squares* show the trigger efficiency using the IP3D+SV1 *b*-tagging algorithm. The *closed circles* show the trigger efficiency for the corresponding MV2 *b*-tagging algorithm working points. The efficiencies are measured in a pure sample of *b*-jets selected in $t\bar{t}$ events and are computed with respect to jets identified by the 70% working point of the offline MV2c20 *b*-tagging algorithm

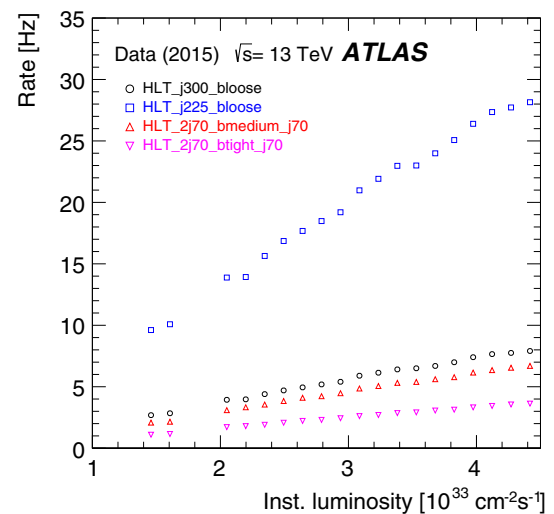

Fig. 47 Rates of *b*-jet triggers as a function of the instantaneous luminosity

The benefit of exploiting *b*-tagging in the HLT can be seen by comparing the thresholds used in jet triggers with and without *b*-tagging. The threshold for the lowest unprescaled single-jet trigger without *b*-tagging is 360 GeV. A *loose* requirement in the trigger allows this threshold to be lowered to 225 GeV. For the four-jet trigger, 85 GeV thresholds are used when no *b*-tagging is applied. Requiring two jets to satisfy the *tight* *b*-tagging requirement allows the four-jet threshold to be lowered to 35 GeV.

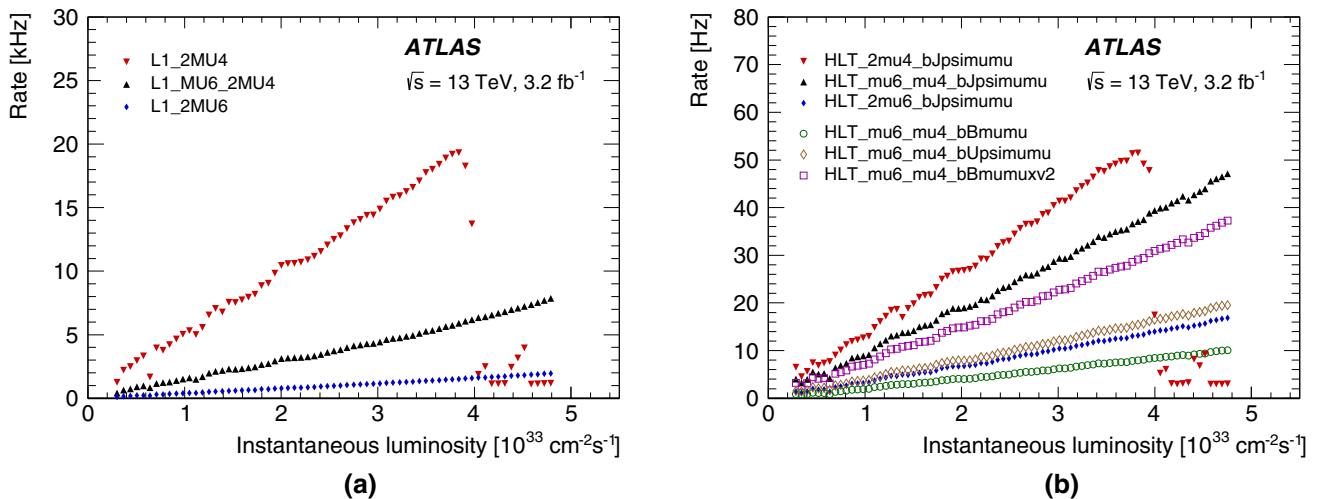

Fig. 48 Trigger rates for **a** low- p_T dimuon L1 triggers with various muon p_T thresholds and **b** primary HLT B -physics triggers as a function of instantaneous luminosity. **b** Shows triggers requiring two muons to pass various p_T thresholds, to have an invariant mass within the J/ψ mass window, and to form a good vertex (*full markers*); also shown are triggers requiring two muons with $p_T > 6$ and 4 GeV and either having

an invariant mass in a different window ($B_{(s)}^0, \Upsilon(1, 2, 3S)$) or forming a $B \rightarrow \mu\mu X$ candidate after combination with additional tracks found in ID (*open markers*). As L1_2MU4 was prescaled at luminosities above $4 \times 10^{33} \text{ cm}^{-2}\text{s}^{-1}$, the rate of 2mu4_bJpsimumu seeded from this L1 trigger drops above that luminosity

6.8 B -physics

The trigger selection of events for B -physics analyses is primarily based on the identification of b -hadrons through decays including a muon pair in the final state. Examples are decays with charmonium, $B \rightarrow J/\psi (\rightarrow \mu\mu) X$, rare decays $B_{(s)}^0 \rightarrow \mu\mu$, and semileptonic $B \rightarrow \mu\mu X$. Decays of prompt charmonium and bottomonium are also identified through their dimuon decays, and are therefore similar to b -hadron decays, apart from the lack of measurable displacement from the pp interaction point.

6.8.1 B -physics reconstruction and selection

The primary suite of triggers require two muons at L1. Their rate is substantially reduced compared to single-muon L1 triggers. However, this results in inefficiencies at high transverse momentum, where the opening angle of the two muons becomes small for low-mass resonances, and the granularity at L1 is not sufficient to form separate RoIs. At the HLT, muons are reconstructed using the same algorithms as described in Sect. 5.3 with the additional requirement that the two muons should have opposite charges and form a good vertex (where the fit is performed using the ID track parameters) within a certain invariant mass window. The primary triggers use three dimuon mass windows: 2.5 to 4.3 GeV intended for the selection of J/ψ and $\psi(2S)$ decays into muon pairs (including charmonia produced in b -hadron decays), 4.0 to 8.5 GeV for $B_{(s)}^0 \rightarrow \mu\mu$ decays, and 8 to 12 GeV for $\Upsilon(1, 2, 3S) \rightarrow \mu\mu$ decays. These invariant mass

selections are indicated by the bJpsimumu, bBmumu and bUpsimumu suffixes in the trigger names, respectively.

Additional primary and supporting triggers are also implemented. Triggers using a single L1 muon RoI with an additional track found at the HLT do not have similar opening angle issues, but suffer from high rates and run with high prescale factors. These combined muon triggers are, however, essential components in data-driven estimates of the dimuon trigger efficiencies. Triggers requiring three muons at L1 help to maintain the lowest muon p_T thresholds for certain event signatures with a likely presence of a third muon. Finally, for selecting semileptonic decays, such as $B^0 \rightarrow \mu\mu K^{*0} (\rightarrow K^+\pi^-)$, searches for additional ID tracks and a combined vertex fit are performed assuming a few exclusive decay hypotheses. This reduces the rate with respect to a simple dimuon vertex selection thus allowing the dimuon mass window to be widened to the full kinematically allowed range. The corresponding trigger names use the bBmumuxv2 suffix.

6.8.2 B -physics trigger menu and rates

Dimuon trigger rate restrictions at L1 define the lowest muon transverse momentum thresholds for primary B -physics triggers in 2015 data-taking. HLT triggers using L1_2MU4 were unprescaled up to a luminosity of $4 \times 10^{33} \text{ cm}^{-2} \text{ s}^{-1}$. Above this, triggers seeded from L1_MU6_2MU4,⁶ which requires

⁶ L1 muon thresholds are inclusive, i.e. L1_MU6_2MU4 is a dimuon trigger.

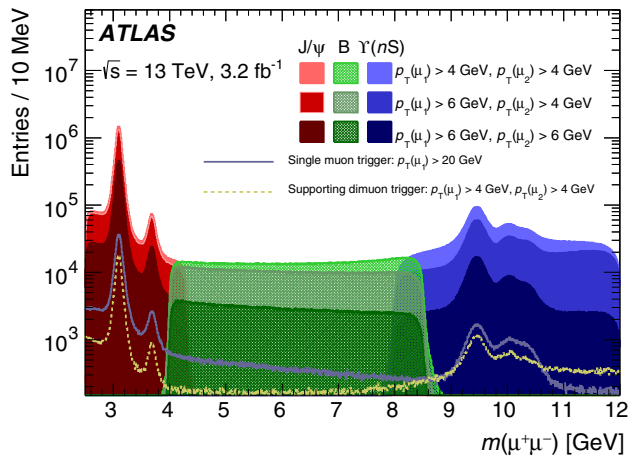

Fig. 49 Invariant mass distribution of offline-selected dimuon candidates passing the lowest thresholds of dimuon B -physics triggers. Triggers targeting different invariant mass ranges are illustrated with different colours, and the differing thresholds are shown with different shadings. No accounting for overlaps between triggers is made, and the distributions are shown overlaid, and not stacked. For comparison, the number of candidates passing the lowest unprescaled single-muon trigger and supporting dimuon trigger is also shown

two muons with p_T above 4 and 6 GeV, were unprescaled. The overall loss of events collected with the former amounts to 15%. Higher-threshold triggers seeded from L1_2MU6 and L1_2MU10 were also active. Figure 48 shows the L1 rates for low- p_T dimuon triggers as well as the HLT rates for various primary triggers seeded from them, as a function of the instantaneous luminosity.

The invariant mass distribution of offline reconstructed dimuon candidates passing the suite of primary triggers is shown in Fig. 49. For comparison, the number of candidates passing the lowest unprescaled single-muon trigger is also shown, as well as the supporting dimuon trigger with wide invariant mass range.

6.8.3 B -physics trigger efficiencies

To evaluate the efficiency of the B -physics selection at the HLT, two supporting triggers with and without the opposite-sign and vertex criteria are used. The first trigger requires that the events contain two opposite-sign muons and form a good fit to a common vertex, using the ID track parameters of the identified muons with a $\chi^2 < 20$ for the one degree-of-freedom. This selection is the same as used in primary dimuon triggers but has a wider invariant mass window. The second trigger differs by the absence of the muon charge selection and vertex fit. The efficiency is calculated using a sample collected by these triggers.

For the efficiency measurement, events are selected by requiring two offline reconstructed combined muons satisfying the *tight* quality selection criteria and $p_T(\mu) > 4$ GeV,

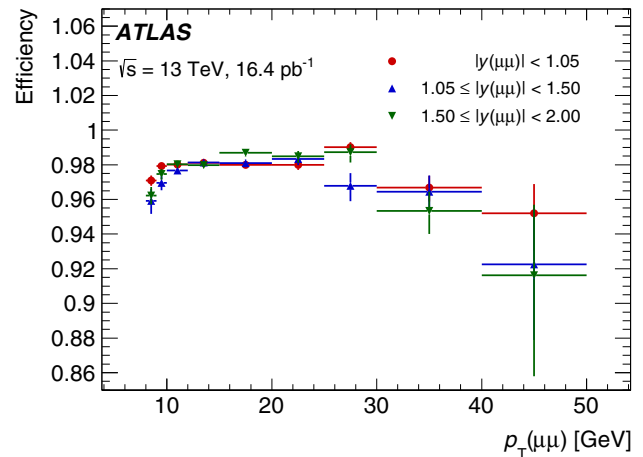

Fig. 50 The efficiency of the opposite-sign muon requirement and vertex quality selection applied for dimuon B -physics triggers as a function of $p_T(\mu\mu)$ for three rapidity regions. Supporting dimuon triggers with and without the selection criteria applied are used to determine the efficiency. The integrated luminosity shown takes into account the high prescale factors applied to the supporting triggers

$|\eta(\mu)| < 2.3$. The offline muons are fit to a common vertex, using their ID track parameters, with a fit quality of $\chi^2/\text{dof} < 10$ and invariant mass $|m(\mu\mu) - m_{J/\psi}| < 0.3$ GeV. The number of J/ψ candidates is determined from a fit to the offline dimuon invariant mass distribution. The efficiency of the opposite-sign muon requirement and vertex quality selection is shown in Fig. 50 as a function of the offline dimuon transverse momentum $p_T(\mu\mu)$ calculated using the track parameters extracted after the vertex fit, for three slices of J/ψ rapidity. The observed small drop in efficiency at high $p_T(\mu\mu)$ is due to the increasing collinearity of the two muons.

7 Conclusion

A large number of trigger upgrades and developments for the ATLAS experiment were made during the first long shutdown of the LHC in preparation for the Run 2 data-taking. A summary of the various updates as well as the first Run 2 performance studies can be found in this paper.

Many improvements in the L1 trigger were implemented including the addition of completely new systems. Upgrades in the L1 calorimeter trigger included the implementation of a dynamic pedestal correction to mitigate pile-up effects. In the L1 muon trigger, a new coincidence logic between the muon end-cap trigger and the innermost muon chamber has been used since 2015, and it is being extended with the hadronic calorimeter, to suppress the fake-muon rate. New chambers were also installed to increase the trigger coverage. In addition, the new central trigger processor doubles the number of L1 trigger thresholds and the L1 output rate limit

has increased from 70 to 100 kHz. Furthermore, a new topological processor was installed and is being commissioned. A new HLT architecture was developed to unify the Level-2 and Event Filter scheme used in Run 1, improving the flexibility of the system. The HLT software was also upgraded, making the algorithms and selections closer to the offline reconstruction to maximise the efficiency, and making use of the newly installed systems such as the innermost pixel layer IBL.

The trigger menu was revisited and redesigned to cope with the greater rates due to the higher centre-of-mass energy and increasing instantaneous luminosity. The different trigger signatures were set up according to the physics needs, considering different luminosity scenarios. The ATLAS trigger system was successfully commissioned with the first data acquired at 13 TeV. First performance studies of the different trigger signatures and trigger efficiencies with respect to the offline quantities are presented using the 13 TeV proton–proton collision data with a 25 ns bunch separation collected during 2015.

Acknowledgements We thank CERN for the very successful operation of the LHC, as well as the support staff from our institutions without whom ATLAS could not be operated efficiently. We acknowledge the support of ANPCyT, Argentina; YerPhI, Armenia; ARC, Australia; BMWFW and FWF, Austria; ANAS, Azerbaijan; SSTC, Belarus; CNPq and FAPESP, Brazil; NSERC, NRC and CFI, Canada; CERN; CONICYT, Chile; CAS, MOST and NSFC, China; COLCIENCIAS, Colombia; MSMT CR, MPO CR and VSC CR, Czech Republic; DNRF and DNSRC, Denmark; IN2P3-CNRS, CEA-DSM/IRFU, France; SRNSF, Georgia; BMBF, HGF, and MPG, Germany; GSRT, Greece; RGC, Hong Kong SAR, China; ISF, I-CORE and Benoziyo Center, Israel; INFN, Italy; MEXT and JSPS, Japan; CNRST, Morocco; NWO, Netherlands; RCN, Norway; MNiSW and NCN, Poland; FCT, Portugal; MNE/IFA, Romania; MES of Russia and NRC KI, Russian Federation; JINR; MESTD, Serbia; MSSR, Slovakia; ARRS and MIZŠ, Slovenia; DST/NRF, South Africa; MINECO, Spain; SRC and Wallenberg Foundation, Sweden; SERI, SNSF and Cantons of Bern and Geneva, Switzerland; MOST, Taiwan; TAEK, Turkey; STFC, United Kingdom; DOE and NSF, USA. In addition, individual groups and members have received support from BCKDF, the Canada Council, CANARIE, CRC, Compute Canada, FQRNT, and the Ontario Innovation Trust, Canada; EPLANET, ERC, ERDF, FP7, Horizon 2020 and Marie Skłodowska-Curie Actions, European Union; Investissements d’Avenir Labex and Idex, ANR, Région Auvergne and Fondation Partager le Savoir, France; DFG and AvH Foundation, Germany; Herakleitos, Thales and Aristeia programmes co-financed by EU-ESF and the Greek NSRF; BSF, GIF and Minerva, Israel; BRF, Norway; CERCA Programme Generalitat de Catalunya, Generalitat Valenciana, Spain; the Royal Society and Leverhulme Trust, United Kingdom. The crucial computing support from all WLCG partners is acknowledged gratefully, in particular from CERN, the ATLAS Tier-1 facilities at TRIUMF (Canada), NDGF (Denmark, Norway, Sweden), CC-IN2P3 (France), KIT/GridKA (Germany), INFN-CNAF (Italy), NL-T1 (Netherlands), PIC (Spain), ASGC (Taiwan), RAL (UK) and BNL (USA), the Tier-2 facilities worldwide and large non-WLCG resource providers. Major contributors of computing resources are listed in Ref. [51].

Open Access This article is distributed under the terms of the Creative Commons Attribution 4.0 International License (<http://creativecommons.org/licenses/by/4.0/>), which permits unrestricted use, distribution,

and reproduction in any medium, provided you give appropriate credit to the original author(s) and the source, provide a link to the Creative Commons license, and indicate if changes were made. Funded by SCOAP³.

References

1. ATLAS Collaboration, Performance of the ATLAS trigger system in 2010. *Eur. Phys. J. C* **72**, 1849 (2012). doi:[10.1140/epjc/s10052-011-1849-1](https://doi.org/10.1140/epjc/s10052-011-1849-1). [arXiv:1110.1530](https://arxiv.org/abs/1110.1530) [hep-ex]
2. ATLAS Collaboration, Performance of the ATLAS electron and photon trigger in pp collisions at $\sqrt{s} = 7$ TeV in 2011. ATLAS-CONF-2012-048 (2012). <http://cds.cern.ch/record/1450089>
3. ATLAS Collaboration, Performance of the ATLAS muon trigger in pp collisions at $\sqrt{s} = 8$ TeV. *Eur. Phys. J. C* **75**, 120 (2015). doi:[10.1140/epjc/s10052-015-3325-9](https://doi.org/10.1140/epjc/s10052-015-3325-9). [arXiv:1408.3179](https://arxiv.org/abs/1408.3179) [hep-ex]
4. ATLAS Collaboration, Identification and energy calibration of hadronically decaying tau leptons with the ATLAS experiment in pp collisions at $\sqrt{s} = 8$ TeV. *Eur. Phys. J. C* **75**, 303 (2015). doi:[10.1140/epjc/s10052-015-3500-z](https://doi.org/10.1140/epjc/s10052-015-3500-z). [arXiv:1412.7086](https://arxiv.org/abs/1412.7086) [hep-ex]
5. ATLAS Collaboration, The performance of the jet trigger for the ATLAS detector during 2011 data taking. *Eur. Phys. J. C* **76**, 526 (2016). doi:[10.1140/epjc/s10052-016-4325-0](https://doi.org/10.1140/epjc/s10052-016-4325-0). [arXiv:1606.07759](https://arxiv.org/abs/1606.07759) [hep-ex]
6. ATLAS Collaboration, The ATLAS experiment at the CERN large hadron collider. *JINST* **3**, S08003 (2008). doi:[10.1088/1748-0221/3/08/S08003](https://doi.org/10.1088/1748-0221/3/08/S08003)
7. ATLAS Collaboration, ATLAS insertable B-layer technical design report. ATLAS-TDR-19 (2010). <http://cds.cern.ch/record/1291633> [ATLAS insertable B-layer technical design report addendum. ATLAS-TDR-19-ADD-1 (2012). <http://cds.cern.ch/record/1451888>]
8. T. Sjöstrand, S. Mrenna, P.Z. Skands, A brief introduction to PYTHIA 8.1. *Comput. Phys. Commun.* **178**, 852 (2008). [arXiv:0710.3820](https://arxiv.org/abs/0710.3820) [hep-ph]
9. R.D. Ball et al., Parton distributions with LHC data. *Nucl. Phys. B* **867**, 244 (2013). [arXiv:1207.1303](https://arxiv.org/abs/1207.1303) [hep-ph]
10. P. Nason, A new method for combining NLO QCD with shower Monte Carlo algorithms. *JHEP* **11**, 040 (2004). [arXiv:hep-ph/0409146](https://arxiv.org/abs/hep-ph/0409146) [hep-ph]
11. S. Frixione, P. Nason, C. Oleari, Matching NLO QCD computations with parton shower simulations: the POWHEG method. *JHEP* **11**, 070 (2007). [arXiv:0709.2092](https://arxiv.org/abs/0709.2092) [hep-ph]
12. S. Alioli et al., A general framework for implementing NLO calculations in shower Monte Carlo programs: the POWHEG BOX. *JHEP* **06**, 043 (2010). [arXiv:1002.2581](https://arxiv.org/abs/1002.2581) [hep-ph]
13. H.-L. Lai et al., New parton distributions for collider physics. *Phys. Rev. D* **82**, 074024 (2010). [arXiv:1007.2241](https://arxiv.org/abs/1007.2241) [hep-ph]
14. T. Sjöstrand, S. Mrenna, P.Z. Skands, PYTHIA 6.4 physics and manual. *JHEP* **0605**, 026 (2006). [arXiv:hep-ph/0603175](https://arxiv.org/abs/hep-ph/0603175) [hep-ph]
15. J. Pumplin et al., New generation of parton distributions with uncertainties from global QCD analysis. *JHEP* **0207**, 012 (2002). [arXiv:hep-ph/0201195](https://arxiv.org/abs/hep-ph/0201195) [hep-ph]
16. ATLAS Collaboration, The ATLAS data acquisition and high level trigger system. *JINST* **11**, P06008 (2016). doi:[10.1088/1748-0221/11/06/P06008](https://doi.org/10.1088/1748-0221/11/06/P06008)
17. ATLAS Collaboration, Technical design report for the phase-I upgrade of the ATLAS TDAQ system. ATLAS-TDR-023 (2013). <http://cdsweb.cern.ch/record/1602235>
18. ATLAS Collaboration, Fast TracKer (FTK) technical design report. ATLAS-TDR-021 (2013). <http://cdsweb.cern.ch/record/1552953>
19. R. Achenbach et al., The ATLAS level-1 calorimeter trigger. *JINST* **3**, P03001 (2008). doi:[10.1088/1748-0221/3/03/P03001](https://doi.org/10.1088/1748-0221/3/03/P03001)

20. B. Asman et al., The ATLAS level-1 calorimeter trigger: PreProcessor implementation and performance. *JINST* **7**, P12008 (2012). doi:[10.1088/1748-0221/7/12/P12008](https://doi.org/10.1088/1748-0221/7/12/P12008)
21. V. Andrei et al., The upgrade of the PreProcessor system of the ATLAS level-1 calorimeter trigger. *JINST* **7**, C12026 (2012). doi:[10.1088/1748-0221/7/12/C12026](https://doi.org/10.1088/1748-0221/7/12/C12026)
22. ATLAS Collaboration, Drift time measurement in the ATLAS liquid argon electromagnetic calorimeter using cosmic muons. *Eur. Phys. J. C* **70**, 755 (2010). doi:[10.1140/epjc/s10052-010-1403-6](https://doi.org/10.1140/epjc/s10052-010-1403-6). arXiv:[1002.4189](https://arxiv.org/abs/1002.4189) [hep-ex]
23. T.J. Barber et al., Resonant bond wire vibrations in the ATLAS semiconductor tracker. *Nucl. Instrum. Methods A* **538**, 442 (2005). doi:[10.1016/j.nima.2004.08.120](https://doi.org/10.1016/j.nima.2004.08.120)
24. ATLAS Collaboration, Trigger monitoring and rate predictions using Enhanced Bias data from the ATLAS Detector at the LHC. ATL-DAQ-PUB-2016-002 (2016). <http://cds.cern.ch/record/2223498>
25. S. van der Meer, Calibration of the effective beam height in the ISR (1968). <http://cds.cern.ch/record/296752>
26. ATLAS Collaboration, Luminosity determination in pp collisions at $\sqrt{s} = 8$ TeV using the ATLAS detector at the LHC. *Eur. Phys. J. C* **76**, 653 (2016). doi:[10.1140/epjc/s10052-016-4466-1](https://doi.org/10.1140/epjc/s10052-016-4466-1). arXiv:[1608.03953](https://arxiv.org/abs/1608.03953) [hep-ex]
27. ATLAS Collaboration, Performance of primary vertex reconstruction in proton–proton collisions at $\sqrt{s} = 7$ TeV in the ATLAS experiment. ATLAS-CONF-2010-069 (2010). <http://cds.cern.ch/record/1281344>
28. ATLAS Collaboration, Topological cell clustering in the ATLAS calorimeters and its performance in LHC Run 1 (2016). arXiv:[1603.02934](https://arxiv.org/abs/1603.02934) [hep-ex]
29. N. Berger et al., The ATLAS high level trigger steering. *J. Phys. Conf. Ser.* **119**, 022013 (2008). doi:[10.1088/1742-6596/119/2/022013](https://doi.org/10.1088/1742-6596/119/2/022013)
30. ATLAS Collaboration, Charged-particle distributions in $\sqrt{s} = 13$ TeV pp interactions measured with the ATLAS detector at the LHC. *Phys. Lett. B* **758**, 67 (2016). doi:[10.1016/j.physletb.2016.04.050](https://doi.org/10.1016/j.physletb.2016.04.050). arXiv:[1602.01633](https://arxiv.org/abs/1602.01633) [hep-ex]
31. ATLAS Collaboration, Measurement of the inelastic proton–proton cross section at $\sqrt{s} = 13$ TeV with the ATLAS detector at the LHC. *Phys. Rev. Lett.* **117**, 182002 (2016). doi:[10.1103/PhysRevLett.117.182002](https://doi.org/10.1103/PhysRevLett.117.182002). arXiv:[1606.02625](https://arxiv.org/abs/1606.02625) [hep-ex]
32. ATLAS Collaboration, Observation of long-range elliptic azimuthal anisotropies in $\sqrt{s} = 13$ and 2.76 TeV pp collisions with the ATLAS detector. *Phys. Rev. Lett.* **116**, 172301 (2016). doi:[10.1103/PhysRevLett.116.172301](https://doi.org/10.1103/PhysRevLett.116.172301). arXiv:[1509.04776](https://arxiv.org/abs/1509.04776) [hep-ex]
33. ATLAS Collaboration, Electron and photon energy calibration with the ATLAS detector using data collected in 2015 at $\sqrt{s} = 13$ TeV. ATL-PHYS-PUB-2016-015 (2016). <http://cds.cern.ch/record/2203514>
34. ATLAS Collaboration, Electron efficiency measurements with the ATLAS detector using the 2015 LHC proton–proton collision data. ATLAS-CONF-2016-024 (2016). <http://cds.cern.ch/record/2157687>
35. ATLAS Collaboration, Photon identification in 2015 ATLAS data. ATL-PHYS-PUB-2016-014 (2016). <http://cds.cern.ch/record/2203125>
36. ATLAS Collaboration, Measurement of the production cross section of prompt J/ψ mesons in association with a W^\pm boson in pp collisions at $\sqrt{s} = 7$ TeV with the ATLAS detector. *JHEP* **04**, 172 (2014). doi:[10.1007/JHEP04\(2014\)172](https://doi.org/10.1007/JHEP04(2014)172). arXiv:[1401.2831](https://arxiv.org/abs/1401.2831) [hep-ex]
37. ATLAS Collaboration, Measurement of the $Z \rightarrow \tau\tau$ cross section with the ATLAS detector. *Phys. Rev. D* **84**, 112006 (2011). doi:[10.1103/PhysRevD.84.112006](https://doi.org/10.1103/PhysRevD.84.112006). arXiv:[1108.2016](https://arxiv.org/abs/1108.2016) [hep-ex]
38. ATLAS Collaboration, Measurements of the Higgs boson production and decay rates and coupling strengths using pp collision data at $\sqrt{s} = 7$ and 8 TeV in the ATLAS experiment. *Eur. Phys. J. C* **76**, 6 (2016). doi:[10.1140/epjc/s10052-015-3769-y](https://doi.org/10.1140/epjc/s10052-015-3769-y). arXiv:[1507.04548](https://arxiv.org/abs/1507.04548) [hep-ex]
39. ATLAS Collaboration, Measurement of W^\pm and Z -boson production cross sections in pp collisions at $\sqrt{s} = 13$ TeV with the ATLAS detector. *Phys. Lett. B* **759**, 601 (2016). doi:[10.1016/j.physletb.2016.06.023](https://doi.org/10.1016/j.physletb.2016.06.023). arXiv:[1603.09222](https://arxiv.org/abs/1603.09222) [hep-ex]
40. ATLAS Collaboration, Measurement of the inclusive cross-sections of single top-quark and top-antiquark t -channel production in pp collisions at $\sqrt{s} = 13$ TeV with the ATLAS detector. *JHEP* **04**, 086 (2017). arXiv:[1609.03920](https://arxiv.org/abs/1609.03920) [hep-ex]
41. ATLAS Collaboration, Measurement of the muon reconstruction performance of the ATLAS detector using 2011 and 2012 LHC proton–proton collision data. *Eur. Phys. J. C* **74**, 3130 (2014). doi:[10.1140/epjc/s10052-014-3130-x](https://doi.org/10.1140/epjc/s10052-014-3130-x). arXiv:[1407.3935](https://arxiv.org/abs/1407.3935) [hep-ex]
42. ATLAS Collaboration, Muon reconstruction performance of the ATLAS detector in proton–proton collision data at $\sqrt{s} = 13$ TeV. *Eur. Phys. J. C* **76**, 292 (2016). doi:[10.1140/epjc/s10052-016-4120-y](https://doi.org/10.1140/epjc/s10052-016-4120-y). arXiv:[1603.05598](https://arxiv.org/abs/1603.05598) [hep-ex]
43. M. Cacciari, G. Salam, G. Soyez, The anti- k_T jet clustering algorithm. *JHEP* **04**, 063 (2008). doi:[10.1088/1126-6708/2008/04/063](https://doi.org/10.1088/1126-6708/2008/04/063). arXiv:[0802.1189](https://arxiv.org/abs/0802.1189) [hep-ph]
44. ATLAS Collaboration, Jet energy measurement and its systematic uncertainty in proton–proton collisions at $\sqrt{s} = 7$ TeV with the ATLAS detector. *Eur. Phys. J. C* **75**, 17 (2015). doi:[10.1140/epjc/s10052-014-3190-y](https://doi.org/10.1140/epjc/s10052-014-3190-y). arXiv:[1406.0076](https://arxiv.org/abs/1406.0076) [hep-ex]
45. B. Nachman, P. Nef, A. Schwartzman, M. Swiatlowski, C. Wanotayaroj, Jets from jets: re-clustering as a tool for large radius jet reconstruction and grooming at the LHC. *JHEP* **02**, 075 (2015). doi:[10.1007/JHEP02\(2015\)075](https://doi.org/10.1007/JHEP02(2015)075). arXiv:[1407.2922](https://arxiv.org/abs/1407.2922) [hep-ph]
46. ATLAS Collaboration, Search for light dijet resonances with the ATLAS detector using a trigger-object level analysis in LHC pp collisions at $\sqrt{s} = 13$ TeV. ATLAS-CONF-2016-030 (2016). <http://cds.cern.ch/record/2161135>
47. ATLAS Collaboration, Reconstruction, energy calibration, and identification of hadronically decaying tau leptons in the ATLAS experiment for run-2 of the LHC. ATL-PHYS-PUB-2015-045 (2015). <http://cds.cern.ch/record/2064383>
48. ATLAS Collaboration, The ATLAS transverse-momentum trigger performance at the LHC in 2011. ATLAS-CONF-2014-002 (2014). <http://cds.cern.ch/record/1647616>
49. ATLAS Collaboration, Performance of b -jet identification in the ATLAS experiment. *JINST* **11**, P04008 (2016). doi:[10.1088/1748-0221/11/04/P04008](https://doi.org/10.1088/1748-0221/11/04/P04008). arXiv:[1512.01094](https://arxiv.org/abs/1512.01094) [hep-ex]
50. ATLAS Collaboration, Expected performance of the ATLAS b -tagging algorithms in Run-2. ATL-PHYS-PUB-2015-022 (2015). <http://cds.cern.ch/record/2037697>
51. ATLAS Collaboration, ATLAS computing acknowledgements 2016–2017. ATL-GEN-PUB-2016-002 (2016). <http://cds.cern.ch/record/2202407>

ATLAS Collaboration

M. Aaboud^{137d}, G. Aad⁸⁸, B. Abbott¹¹⁵, J. Abdallah⁸, O. Abidinov¹², B. Abeloos¹¹⁹, R. Aben¹⁰⁹, O. S. AbouZeid¹³⁹, N. L. Abraham¹⁵¹, H. Abramowicz¹⁵⁵, H. Abreu¹⁵⁴, R. Abreu¹¹⁸, Y. Abulaiti^{148a,148b}, B. S. Acharya^{167a,167b,a}, S. Adachi¹⁵⁷, L. Adamczyk^{41a}, D. L. Adams²⁷, J. Adelman¹¹⁰, S. Adomeit¹⁰², T. Adye¹³³, A. A. Affolder⁷⁷, T. Agatonovic-Jovin¹⁴, J. A. Aguilar-Saavedra^{128a,128f}, S. P. Ahlen²⁴, F. Ahmadov^{68,b}, G. Aielli^{135a,135b}, H. Akerstedt^{148a,148b}, T. P. A. Åkesson⁸⁴, A. V. Akimov⁹⁸, G. L. Alberghi^{22a,22b}, J. Albert¹⁷², S. Albrand⁵⁸, M. J. Alconada Verzini⁷⁴, M. Aleksa³², I. N. Aleksandrov⁶⁸, C. Alexa^{28b}, G. Alexander¹⁵⁵, T. Alexopoulos¹⁰, M. Alhroob¹¹⁵, B. Ali¹³⁰, M. Aliev^{76a,76b}, G. Alimonti^{94a}, J. Alison³³, S. P. Alkire³⁸, B. M. M. Allbrooke¹⁵¹, B. W. Allen¹¹⁸, P. P. Allport¹⁹, A. Aloisio^{106a,106b}, A. Alonso³⁹, F. Alonso⁷⁴, C. Alpigiani¹⁴⁰, A. A. Alshehri⁵⁶, M. Alstary⁸⁸, B. Alvarez Gonzalez³², D. Álvarez Piqueras¹⁷⁰, M. G. Alviggi^{106a,106b}, B. T. Amadio¹⁶, Y. Amaral Coutinho^{26a}, C. Amelung²⁵, D. Amidei⁹², S. P. Amor Dos Santos^{128a,128c}, A. Amorim^{128a,128b}, S. Amoroso³², G. Amundsen²⁵, C. Anastopoulos¹⁴¹, L. S. Ancu⁵², N. Andari¹⁹, T. Andeen¹¹, C. F. Anders^{60b}, G. Anders³², J. K. Anders⁷⁷, K. J. Anderson³³, A. Andreazza^{94a,94b}, V. Andrei^{60a}, S. Angelidakis⁹, I. Angelozzi¹⁰⁹, A. Angerami³⁸, F. Anghinolfi³², A. V. Anisenkov^{111,c}, N. Anjos¹³, A. Annovi^{126a,126b}, C. Antel^{60a}, M. Antonelli⁵⁰, A. Antonov^{100,*}, D. J. Antrim¹⁶⁶, F. Anulli^{134a}, M. Aoki⁶⁹, L. Aperio Bella¹⁹, G. Arabidze⁹³, Y. Arai⁶⁹, J. P. Araque^{128a}, A. T. H. Arce⁴⁸, F. A. Arduh⁷⁴, J.-F. Arguin⁹⁷, S. Argyropoulos⁶⁶, M. Arik^{20a}, A. J. Armbruster¹⁴⁵, L. J. Armitage⁷⁹, O. Arnaez³², H. Arnold⁵¹, M. Arratia³⁰, O. Arslan²³, A. Artamonov⁹⁹, G. Artoni¹²², S. Artz⁸⁶, S. Asai¹⁵⁷, N. Asbah⁴⁵, A. Ashkenazi¹⁵⁵, B. Åsman^{148a,148b}, L. Asquith¹⁵¹, K. Assamagan²⁷, R. Astalos^{146a}, M. Atkinson¹⁶⁹, N. B. Atlay¹⁴³, K. Augsten¹³⁰, G. Avolio³², B. Axen¹⁶, M. K. Ayoub¹¹⁹, G. Azuelos^{97,d}, M. A. Baak³², A. E. Baas^{60a}, M. J. Baca¹⁹, H. Bachacou¹³⁸, K. Bachas^{76a,76b}, M. Backes¹²², M. Backhaus³², P. Bagiachi^{134a,134b}, P. Bagnaia^{134a,134b}, Y. Bai^{35a}, J. T. Baines¹³³, M. Bajic³⁹, O. K. Baker¹⁷⁹, E. M. Baldin^{111,c}, P. Balek¹⁷⁵, T. Balestri¹⁵⁰, F. Balli¹³⁸, W. K. Balunas¹²⁴, E. Banas⁴², Sw. Banerjee^{176,e}, A. A. E. Bannoura¹⁷⁸, L. Barak³², E. L. Barberio⁹¹, D. Barberis^{53a,53b}, M. Barbero⁸⁸, T. Barillari¹⁰³, M.-S. Barisits³², T. Barklow¹⁴⁵, N. Barlow³⁰, S. L. Barnes⁸⁷, B. M. Barnett¹³³, R. M. Barnett¹⁶, Z. Barnovska-Blenessy^{36a}, A. Baroncelli^{136a}, G. Barone²⁵, A. J. Barr¹²², L. Barranco Navarro¹⁷⁰, F. Barreiro⁸⁵, J. Barreiro Guimarães da Costa^{35a}, R. Bartoldus¹⁴⁵, A. E. Barton⁷⁵, P. Bartos^{146a}, A. Basalae¹²⁵, A. Bassalat^{119,f}, R. L. Bates⁵⁶, S. J. Batista¹⁶¹, J. R. Batley³⁰, M. Battaglia¹³⁹, M. Bauce^{134a,134b}, F. Bauer¹³⁸, H. S. Bawa^{145,g}, J. B. Beacham¹¹³, M. D. Beattie⁷⁵, T. Beau⁸³, P. H. Beauchemin¹⁶⁵, P. Bechtel²³, H. P. Beck^{18,h}, K. Becker¹²², M. Becker⁸⁶, M. Beckingham¹⁷³, C. Becot¹¹², A. J. Beddall^{20d}, A. Beddall^{20b}, V. A. Bednyakov⁶⁸, M. Bedognetti¹⁰⁹, C. P. Bee¹⁵⁰, L. J. Beemster¹⁰⁹, T. A. Beermann³², M. Begel²⁷, J. K. Behr⁴⁵, A. S. Bell⁸¹, G. Bella¹⁵⁵, L. Bellagamba^{22a}, A. Bellerive³¹, M. Bellomo⁸⁹, K. Belotskiy¹⁰⁰, O. Beltramello³², N. L. Belyaev¹⁰⁰, O. Benary^{155,*}, D. Benckekroun^{137a}, M. Bender¹⁰², K. Bendtz^{148a,148b}, N. Benekos¹⁰, Y. Benhammou¹⁵⁵, E. Benhar Nocchioli¹⁷⁹, J. Benitez⁶⁶, D. P. Benjamin⁴⁸, J. R. Bensinger²⁵, S. Bentvelsen¹⁰⁹, L. Beresford¹²², M. Beretta⁵⁰, D. Berge¹⁰⁹, E. Bergeas Kuutmann¹⁶⁸, N. Berger⁵, J. Beringer¹⁶, S. Berlendis⁵⁸, N. R. Bernard⁸⁹, C. Bernius¹¹², F. U. Bernlochner²³, T. Berry⁸⁰, P. Berta¹³¹, C. Bertella⁸⁶, G. Bertoli^{148a,148b}, F. Bertolucci^{126a,126b}, I. A. Bertram⁷⁵, C. Bertsche⁴⁵, D. Bertsche¹¹⁵, G. J. Besjes³⁹, O. Bessidskaia Bylund^{148a,148b}, M. Bessner⁴⁵, N. Besson¹³⁸, C. Betancourt⁵¹, A. Bethani⁵⁸, S. Bethke¹⁰³, A. J. Bevan⁷⁹, R. M. Bianchi¹²⁷, M. Bianco³², O. Biebel¹⁰², D. Biedermann¹⁷, R. Bielski⁸⁷, N. V. Biesuz^{126a,126b}, M. Biglietti^{136a}, J. Bilbao De Mendizabal⁵², T. R. V. Billoud⁹⁷, H. Bilokon⁵⁰, M. Bindi⁵⁷, A. Bingul^{20b}, C. Bini^{134a,134b}, S. Biondi^{22a,22b}, T. Bisanz⁵⁷, D. M. Bjergaard⁴⁸, C. W. Black¹⁵², J. E. Black¹⁴⁵, K. M. Black²⁴, D. Blackburn¹⁴⁰, R. E. Blair⁶, T. Blazek^{146a}, I. Bloch⁴⁵, C. Blocker²⁵, A. Blue⁵⁶, W. Blum^{86,*}, U. Blumenschein⁵⁷, S. Blunier^{34a}, G. J. Bobbink¹⁰⁹, V. S. Bobrovnikov^{111,c}, S. S. Bocchetta⁸⁴, A. Bocchi⁴⁸, C. Bock¹⁰², M. Boehler⁵¹, D. Boerner¹⁷⁸, J. A. Bogaerts³², D. Bogavac¹⁴, A. G. Bogdanchikov¹¹¹, C. Bohm^{148a}, V. Boisvert⁸⁰, P. Bokan¹⁴, T. Bold^{41a}, A. S. Boldyrev¹⁰¹, M. Bomben⁸³, M. Bona⁷⁹, M. Boonekamp¹³⁸, A. Borisov¹³², G. Borissov⁷⁵, J. Bortfeldt³², D. Bortoletto¹²², V. Bortolotto^{62a,62b,62c}, K. Bos¹⁰⁹, D. Boscherini^{22a}, M. Bosman¹³, J. D. Bossio Sola²⁹, J. Boudreau¹²⁷, J. Bouffard², E. V. Bouhova-Thacker⁷⁵, D. Boumediene³⁷, C. Bourdarios¹¹⁹, S. K. Boutle⁵⁶, A. Boveia³², J. Boyd³², I. R. Boyko⁶⁸, J. Bracinik¹⁹, A. Brandt⁸, G. Brandt⁵⁷, O. Brandt^{60a}, U. Bratzler¹⁵⁸, B. Brau⁸⁹, J. E. Brau¹¹⁸, W. D. Breaden Madden⁵⁶, K. Brendlinger¹²⁴, A. J. Brennan⁹¹, L. Brenner¹⁰⁹, R. Brenner¹⁶⁸, S. Bressler¹⁷⁵, T. M. Bristow⁴⁹, D. Britton⁵⁶, D. Britzger⁴⁵, F. M. Brochu³⁰, I. Brock²³, R. Brock⁹³, G. Brooijmans³⁸, T. Brooks⁸⁰, W. K. Brooks^{34b}, J. Brosamer¹⁶, E. Brost¹¹⁰, J. H. Broughton¹⁹, P. A. Bruckman de Renstrom⁴², D. Bruncko^{146b}, R. Bruneliere⁵¹, A. Bruni^{22a}, G. Bruni^{22a}, L. S. Bruni¹⁰⁹, BH Brunt³⁰, M. Bruschi^{22a}, N. Bruscino²³, P. Bryant³³, L. Bryngemark⁸⁴, T. Buanes¹⁵, Q. Buat¹⁴⁴, P. Buchholz¹⁴³, A. G. Buckley⁵¹, I. A. Budagov⁶⁸, F. Buehrer⁵¹, M. K. Bugge¹²¹, O. Bulekov¹⁰⁰, D. Bullock⁸, H. Burckhart³², S. Burdin⁷⁷, C. D. Burgard⁵¹, A. M. Burger⁵, B. Burghgrave¹¹⁰, K. Burka⁴², S. Burke¹³³, I. Burmeister⁴⁶, J. T. P. Burr¹²², E. Busato³⁷, D. Büscher⁵¹, V. Büscher⁸⁶, P. Bussey⁵⁶, J. M. Butler²⁴, C. M. Buttar⁵⁶, J. M. Butterworth⁸¹, P. Butti¹⁰⁹, W. Buttinger²⁷, A. Buzatu⁵⁶, A. R. Buzykaev^{111,c}, S. Cabrera Urbán¹⁷⁰, D. Caforio¹³⁰,

V. M. Cairo^{40a,40b}, O. Cakir^{4a}, N. Calace⁵², P. Calafiura¹⁶, A. Calandri⁸⁸, G. Calderini⁸³, P. Calfayan⁶⁴, G. Callea^{40a,40b}, L. P. Caloba^{26a}, S. Calvente Lopez⁸⁵, D. Calvet³⁷, S. Calvet³⁷, T. P. Calvet⁸⁸, R. Camacho Toro³³, S. Camarda³², P. Camarri^{135a,135b}, D. Cameron¹²¹, R. Caminal Armadans¹⁶⁹, C. Camincher⁵⁸, S. Campana³², M. Campanelli⁸¹, A. Camplani^{94a,94b}, A. Campoverde¹⁴³, V. Canale^{106a,106b}, A. Canepa^{163a}, M. Cano Bret^{36c}, J. Cantero¹¹⁶, T. Cao¹⁵⁵, M. D. M. Capeans Garrido³², I. Caprini^{28b}, M. Caprini^{28b}, M. Capua^{40a,40b}, R. M. Carbone³⁸, R. Cardarelli^{135a}, F. Cardillo⁵¹, I. Carli¹³¹, T. Carli³², G. Carlino^{106a}, B. T. Carlson¹²⁷, L. Carminati^{94a,94b}, R. M. D. Carney^{148a,148b}, S. Caron¹⁰⁸, E. Carquin^{34b}, G. D. Carrillo-Montoya³², J. R. Carter³⁰, J. Carvalho^{128a,128c}, D. Casadei¹⁹, M. P. Casado^{13.i}, M. Casolino¹³, D. W. Casper¹⁶⁶, E. Castaneda-Miranda^{147a}, R. Castelijm¹⁰⁹, A. Castelli¹⁰⁹, V. Castillo Gimenez¹⁷⁰, N. F. Castro^{128a,j}, A. Catinaccio³², J. R. Catmore¹²¹, A. Cattai³², J. Caudron²³, V. Cavaliere¹⁶⁹, E. Cavallaro¹³, D. Cavalli^{94a}, M. Cavalli-Sforza¹³, V. Cavasinni^{126a,126b}, F. Ceradini^{136a,136b}, L. Cerda Alberich¹⁷⁰, A. S. Cerqueira^{26b}, A. Cerri¹⁵¹, L. Cerrito^{135a,135b}, F. Cerutti¹⁶, A. Cervelli¹⁸, S. A. Cetin^{20c}, A. Chafaq^{137a}, D. Chakraborty¹¹⁰, S. K. Chan⁵⁹, Y. L. Chan^{62a}, P. Chang¹⁶⁹, J. D. Chapman³⁰, D. G. Charlton¹⁹, A. Chatterjee⁵², C. C. Chau¹⁶¹, C. A. Chavez Barajas¹⁵¹, S. Che¹¹³, S. Cheatham^{167a,167c}, A. Chegwiddden⁹³, S. Chekanov⁶, S. V. Chekulaev^{163a}, G. A. Chelkov^{68,k}, M. A. Chelstowska⁹², C. Chen⁶⁷, H. Chen²⁷, K. Chen¹⁵⁰, S. Chen^{35b}, S. Chen¹⁵⁷, X. Chen^{35c}, Y. Chen⁷⁰, H. C. Cheng⁹², H. J. Cheng^{35a}, Y. Cheng³³, A. Cheplakov⁶⁸, E. Cheremushkina¹³², R. Cherkaoui El Moursli^{137e}, V. Chernyatin^{27,*}, E. Cheu⁷, L. Chevalier¹³⁸, V. Chiarella⁵⁰, G. Chiarelli^{126a,126b}, G. Chiodini^{76a}, A. S. Chisholm³², A. Chitan^{28b}, M. V. Chizhov⁶⁸, K. Choi⁶⁴, A. R. Chomont³⁷, S. Chouridou⁹, B. K. B. Chow¹⁰², V. Christodoulou⁸¹, D. Chromek-Burckhart³², J. Chudoba¹²⁹, A. J. Chuinard⁹⁰, J. J. Chwastowski⁴², L. Chytka¹¹⁷, G. Ciapetti^{134a,134b}, A. K. Ciftci^{4a}, D. Cinca⁴⁶, V. Cindro⁷⁸, I. A. Cioara²³, C. Ciocca^{22a,22b}, A. Ciocio¹⁶, F. Ciroto^{106a,106b}, Z. H. Citron¹⁷⁵, M. Citterio^{94a}, M. Ciubancan^{28b}, A. Clark⁵², B. L. Clark⁵⁹, M. R. Clark³⁸, P. J. Clark⁴⁹, R. N. Clarke¹⁶, C. Clement^{148a,148b}, Y. Coadou⁸⁸, M. Cobal^{167a,167c}, A. Coccaro⁵², J. Cochran⁶⁷, L. Colasurdo¹⁰⁸, B. Cole³⁸, A. P. Colijn¹⁰⁹, J. Collot⁵⁸, T. Colombo¹⁶⁶, G. Compostella¹⁰³, P. Conde Muiño^{128a,128b}, E. Coniavitis⁵¹, S. H. Connell^{147b}, I. A. Connelly⁸⁰, V. Consorti⁵¹, S. Constantinescu^{28b}, G. Conti³², F. Conventi^{106a,l}, M. Cooke¹⁶, B. D. Cooper⁸¹, A. M. Cooper-Sarkar¹²², F. Cormier¹⁷¹, K. J. R. Cormier¹⁶¹, T. Cornelissen¹⁷⁸, M. Corradi^{134a,134b}, F. Corriveau^{90,m}, A. Cortes-Gonzalez³², G. Cortiana¹⁰³, G. Costa^{94a}, M. J. Costa¹⁷⁰, D. Costanzo¹⁴¹, G. Cottin³⁰, G. Cowan⁸⁰, B. E. Cox⁸⁷, K. Cranmer¹¹², S. J. Crawley⁵⁶, G. Cree³¹, S. Crépe-Renaudin⁵⁸, F. Crescioli⁸³, W. A. Cribbs^{148a,148b}, M. Crispin Ortuzar¹²², M. Cristinziani²³, V. Croft¹⁰⁸, G. Crosetti^{40a,40b}, A. Cueto⁸⁵, T. Cuhadar Donszelmann¹⁴¹, J. Cummings¹⁷⁹, M. Curatolo⁵⁰, J. Cúth⁸⁶, H. Czir¹⁴³, P. Czodrowski³, G. D'amen^{22a,22b}, S. D'Auria⁵⁶, M. D'Onofrio⁷⁷, M. J. Da Cunha Sargedas De Sousa^{128a,128b}, C. Da Via⁸⁷, W. Dabrowski^{41a}, T. Dado^{146a}, T. Dai⁹², O. Dale¹⁵, F. Dallaire⁹⁷, C. Dallapiccola⁸⁹, M. Dam³⁹, J. R. Dandoy³³, N. P. Dang⁵¹, A. C. Daniells¹⁹, N. S. Dann⁸⁷, M. Danninger¹⁷¹, M. Dano Hoffmann¹³⁸, V. Dao⁵¹, G. Darbo^{53a}, S. Darmora⁸, J. Dassoulas³, A. Dattagupta¹¹⁸, W. Davey²³, C. David¹⁷², T. Davidek¹³¹, M. Davies¹⁵⁵, P. Davison⁸¹, E. Dawe⁹¹, I. Dawson¹⁴¹, K. De⁸, R. de Asmundis^{106a}, A. De Benedetti¹¹⁵, S. De Castro^{22a,22b}, S. De Cecco⁸³, N. De Groot¹⁰⁸, P. de Jong¹⁰⁹, H. De la Torre⁹³, F. De Lorenzi⁶⁷, A. De Maria⁵⁷, D. De Pedis^{134a}, A. De Salvo^{134a}, U. De Sanctis¹⁵¹, A. De Santo¹⁵¹, J. B. De Vivie De Regie¹¹⁹, W. J. Dearnaley⁷⁵, R. Debbé²⁷, C. Debenedetti¹³⁹, D. V. Dedovich⁶⁸, N. Dehghanian³, I. Deigaard¹⁰⁹, M. Del Gaudio^{40a,40b}, J. Del Peso⁸⁵, T. Del Prete^{126a,126b}, D. Delgove¹¹⁹, F. Deliot¹³⁸, C. M. Delitzsch⁵², A. Dell'Acqua³², L. Dell'Asta²⁴, M. Dell'Orso^{126a,126b}, M. Della Pietra^{106a,l}, D. della Volpe⁵², M. Delmastro⁵, P. A. Delsart⁵⁸, D. A. DeMarco¹⁶¹, S. Demers¹⁷⁹, M. Demichev⁶⁸, A. Demilly⁸³, S. P. Denisov¹³², D. Denysiuk¹³⁸, D. Derendarz⁴², J. E. Derkaoui^{137d}, F. Derue⁸³, P. Dervan⁷⁷, K. Desch²³, C. Deterre⁴⁵, K. Dette⁴⁶, P. O. Deviveiros³², A. Dewhurst¹³³, S. Dhaliwal²⁵, A. Di Ciaccio^{135a,135b}, L. Di Ciaccio⁵, W. K. Di Clemente¹²⁴, C. Di Donato^{106a,106b}, A. Di Girolamo³², B. Di Girolamo³², B. Di Micco^{136a,136b}, R. Di Nardo³², A. Di Simone⁵¹, R. Di Sipio¹⁶¹, D. Di Valentino³¹, C. Diaconu⁸⁸, M. Diamond¹⁶¹, F. A. Dias⁴⁹, M. A. Diaz^{34a}, E. B. Diehl⁹², J. Dietrich¹⁷, S. Díez Cornell⁴⁵, A. Dimitrievska¹⁴, J. Dingfelder²³, P. Dita^{28b}, S. Dita^{28b}, F. Dittus³², F. Djama⁸⁸, T. Djobava^{54b}, J. I. Djuvsland^{60a}, M. A. B. do Vale^{26c}, D. Dobos³², M. Dobre^{28b}, C. Doglioni⁸⁴, J. Dolejsi¹³¹, Z. Dolezal¹³¹, M. Donadelli^{26d}, S. Donati^{126a,126b}, P. Dondero^{123a,123b}, J. Donini³⁷, J. Dopke¹³³, A. Doria^{106a}, M. T. Dova⁷⁴, A. T. Doyle⁵⁶, E. Drechsler⁵⁷, M. Dris¹⁰, Y. Du^{36b}, J. Duarte-Campderros¹⁵⁵, E. Duchovni¹⁷⁵, G. Duckeck¹⁰², O. A. Ducu^{97,n}, D. Duda¹⁰⁹, A. Dudarev³², A. Chr. Dudder⁸⁶, E. M. Duffield¹⁶, L. Duflo¹¹⁹, M. Dührssen³², M. Dumancic¹⁷⁵, A. K. Duncan⁵⁶, M. Dunford^{60a}, H. Duran Yildiz^{4a}, M. Düren⁵⁵, A. Durglishvili^{54b}, D. Duschinger⁴⁷, B. Dutta⁴⁵, M. Dyndal⁴⁵, C. Eckardt⁴⁵, K. M. Ecker¹⁰³, R. C. Edgar⁹², N. C. Edwards⁴⁹, T. Eifert³², G. Eigen¹⁵, K. Einsweiler¹⁶, T. Ekelof¹⁶⁸, M. El Kacimi^{137c}, V. Ellajosyula⁸⁸, M. Ellert¹⁶⁸, S. Elles⁵, F. Ellinghaus¹⁷⁸, A. A. Elliot¹⁷², N. Ellis³², J. Elmsheuser²⁷, M. Elsing³², D. Emelianov¹³³, Y. Enari¹⁵⁷, O. C. Endner⁸⁶, J. S. Ennis¹⁷³, J. Erdmann⁴⁶, A. Ereditato¹⁸, G. Ernis¹⁷⁸, J. Ernst², M. Ernst²⁷, S. Errede¹⁶⁹, E. Ertel⁸⁶, M. Escalier¹¹⁹, H. Esch⁴⁶, C. Escobar¹²⁷, B. Esposito⁵⁰, A. I. Etienve¹³⁸, E. Etzion¹⁵⁵, H. Evans⁶⁴, A. Ezhilov¹²⁵, M. Ezzi^{137e}, F. Fabbri^{22a,22b}, L. Fabbri^{22a,22b}, G. Facini³³, R. M. Fakhrutdinov¹³², S. Falciano^{134a}, R. J. Falla⁸¹, J. Faltova³², Y. Fang^{35a}, M. Fanti^{94a,94b}, A. Farbin⁸,

A. Farilla^{136a}, C. Farina¹²⁷, E. M. Farina^{123a,123b}, T. Faroouque¹³, S. Farrell¹⁶, S. M. Farrington¹⁷³, P. Farthouat³², F. Fassi^{137e}, P. Fassnacht³², D. Fassouliotis⁹, M. Faucci Giannelli⁸⁰, A. Favareto^{53a,53b}, W. J. Fawcett¹²², L. Fayard¹¹⁹, O. L. Fedin^{125,o}, W. Fedorko¹⁷¹, S. Feigl¹²¹, L. Feligioni⁸⁸, C. Feng^{36b}, E. J. Feng³², H. Feng⁹², A. B. Fenyuk¹³², L. Feremenga⁸, P. Fernandez Martinez¹⁷⁰, S. Fernandez Perez¹³, J. Ferrando⁴⁵, A. Ferrari¹⁶⁸, P. Ferrari¹⁰⁹, R. Ferrari^{123a}, D. E. Ferreira de Lima^{60b}, A. Ferrer¹⁷⁰, D. Ferrere⁵², C. Ferretti⁹², F. Fiedler⁸⁶, A. Filipčić⁷⁸, M. Filipuzzi⁴⁵, F. Filthaut¹⁰⁸, M. Fincke-Keeler¹⁷², K. D. Finelli¹⁵², M. C. N. Fiolhais^{128a,128c}, L. Fiorini¹⁷⁰, A. Fischer², C. Fischer¹³, J. Fischer¹⁷⁸, W. C. Fisher⁹³, N. Flaschel⁴⁵, I. Fleck¹⁴³, P. Fleischmann⁹², G. T. Fletcher¹⁴¹, R. R. M. Fletcher¹²⁴, T. Flick¹⁷⁸, B. M. Flierl¹⁰², L. R. Flores Castillo^{62a}, M. J. Flowerdew¹⁰³, G. T. Forcolin⁸⁷, A. Formica¹³⁸, A. Forti⁸⁷, A. G. Foster¹⁹, D. Fournier¹¹⁹, H. Fox⁷⁵, S. Fracchia¹³, P. Francavilla⁸³, M. Franchini^{22a,22b}, D. Francis³², L. Franconi¹²¹, M. Franklin⁵⁹, M. Frate¹⁶⁶, M. Fraternali^{123a,123b}, D. Freeborn⁸¹, S. M. Fressard-Batraneau³², F. Friedrich⁴⁷, D. Froidevaux³², J. A. Frost¹²², C. Fukunaga¹⁵⁸, E. Fullana Torregrosa⁸⁶, T. Fusayasu¹⁰⁴, J. Fuster¹⁷⁰, C. Gabaldon⁵⁸, O. Gabizon¹⁵⁴, A. Gabrielli^{22a,22b}, A. Gabrielli¹⁶, G. P. Gach^{41a}, S. Gadatsch³², G. Gagliardi^{53a,53b}, L. G. Gagnon⁹⁷, P. Gagnon⁶⁴, C. Galea¹⁰⁸, B. Galhardo^{128a,128c}, E. J. Gallas¹²², B. J. Gallop¹³³, P. Gallus¹³⁰, G. Galster³⁹, K. K. Gan¹¹³, S. Ganguly³⁷, J. Gao^{36a}, Y. Gao⁴⁹, Y. S. Gao^{145,g}, F. M. Garay Walls⁴⁹, C. García¹⁷⁰, J. E. García Navarro¹⁷⁰, M. Garcia-Sciveres¹⁶, R. W. Gardner³³, N. Garelli¹⁴⁵, V. Garonne¹²¹, A. Gascon Bravo⁴⁵, K. Gasnikova⁴⁵, C. Gatti⁵⁰, A. Gaudiello^{53a,53b}, G. Gaudio^{123a}, L. Gauthier⁹⁷, I. L. Gavrilenko⁹⁸, C. Gay¹⁷¹, G. Gaycken²³, E. N. Gazizadeh¹⁰, Z. Gece¹⁷¹, C. N. P. Gee¹³³, Ch. Geich-Gimbel²³, M. Geisen⁸⁶, M. P. Geisler^{60a}, K. Gellerstedt^{148a,148b}, C. Gemme^{53a}, M. H. Genest⁵⁸, C. Geng^{36a,p}, S. Gentile^{134a,134b}, C. Gentsos¹⁵⁶, S. George⁸⁰, D. Gerbaudo¹³, A. Gershon¹⁵⁵, S. Ghasemi¹⁴³, M. Ghneimat²³, B. Giacobbe^{22a}, S. Giagu^{134a,134b}, P. Giannetti^{126a,126b}, S. M. Gibson⁸⁰, M. Gignac¹⁷¹, M. Gilchriese¹⁶, T. P. S. Gillam³⁰, D. Gillberg³¹, G. Gilles¹⁷⁸, D. M. Gingrich^{3,d}, N. Giokaris^{9,*}, M. P. Giordani^{167a,167c}, F. M. Giorgi^{22a}, P. F. Giraud¹³⁸, P. Giromini⁵⁹, D. Giugni^{94a}, F. Giuli¹²², C. Giuliani¹⁰³, M. Giulini^{60b}, B. K. Gjelsten¹²¹, S. Gkaitatzis¹⁵⁶, I. Gkiyalas¹⁵⁶, E. L. Gkougkousis¹¹⁹, L. K. Gladilin¹⁰¹, C. Glasman⁸⁵, J. Glatzer¹³, P. C. F. Glaysher⁴⁹, A. Glazov⁴⁵, M. Goblirsch-Kolb²⁵, J. Godlewski⁴², S. Goldfarb⁹¹, T. Golling⁵², D. Golubkov¹³², A. Gomes^{128a,128b,128d}, R. Gonçalves^{128a}, J. Goncalves Pinto Firmino Da Costa¹³⁸, G. Gonella⁵¹, L. Gonella¹⁹, A. Gongadze⁶⁸, S. González de la Hoz¹⁷⁰, S. Gonzalez-Sevilla⁵², L. Goossens³², P. A. Gorbounov⁹⁹, H. A. Gordon²⁷, I. Gorelov¹⁰⁷, B. Gorini³², E. Gorini^{76a,76b}, A. Gorišek⁷⁸, E. Gornicki⁴², A. T. Goshaw⁴⁸, C. Gössling⁴⁶, M. I. Gostkin⁶⁸, C. R. Goudet¹¹⁹, D. Goujdami^{137c}, A. G. Goussiou¹⁴⁰, N. Govender^{147b,q}, E. Gozani¹⁵⁴, L. Graber⁵⁷, I. Grabowska-Bold^{41a}, P. O. J. Gradin⁵⁸, P. Grafström^{22a,22b}, J. Gramling⁵², E. Gramstad¹²¹, S. Grancagnolo¹⁷, V. Gratchev¹²⁵, P. M. Gravila^{28e}, H. M. Gray³², E. Graziani^{136a}, Z. D. Greenwood^{82,r}, C. Grefe²³, K. Gregersen⁸¹, I. M. Gregor⁴⁵, P. Grenier¹⁴⁵, K. Grevtsov⁵, J. Griffiths⁸, A. A. Grillo¹³⁹, K. Grimm⁷⁵, S. Grinstein^{13,s}, Ph. Gris³⁷, J.-F. Grivaz¹¹⁹, S. Groh⁸⁶, E. Gross¹⁷⁵, J. Grosse-Knetter⁵⁷, G. C. Grossi⁸², Z. J. Grout⁸¹, L. Guan⁹², W. Guan¹⁷⁶, J. Guenther⁶⁵, F. Guescini⁵², D. Guest¹⁶⁶, O. Gueta¹⁵⁵, B. Gui¹¹³, E. Guido^{53a,53b}, T. Guillemin⁵, S. Guindon², U. Gul⁵⁶, C. Gumpert³², J. Guo^{36c}, Y. Guo^{36a,p}, R. Gupta⁴³, S. Gupta¹²², G. Gustavino^{134a,134b}, P. Gutierrez¹¹⁵, N. G. Gutierrez Ortiz⁸¹, C. Gutsche⁸¹, C. Guyot¹³⁸, C. Gwenlan¹²², C. B. Gwilliam⁷⁷, A. Haas¹¹², C. Haber¹⁶, H. K. Hadavand⁸, N. Haddad^{137e}, A. Hader⁸⁸, S. Hageböck²³, M. Hagihara¹⁶⁴, Z. Hajduk⁴², H. Hakobyan^{180,*}, M. Haleem⁴⁵, J. Haley¹¹⁶, G. Halladjian⁹³, G. D. Hallewell⁸⁸, K. Hamacher¹⁷⁸, P. Hamal¹¹⁷, K. Hamano¹⁷², A. Hamilton^{147a}, G. N. Hamity¹⁴¹, P. G. Hamnett⁴⁵, L. Han^{36a}, K. Hanagaki^{69,t}, K. Hanawa¹⁵⁷, M. Hance¹³⁹, B. Haney¹²⁴, P. Hanke^{60a}, R. Hanna¹³⁸, J. B. Hansen³⁹, J. D. Hansen³⁹, M. C. Hansen²³, P. H. Hansen³⁹, K. Hara¹⁶⁴, A. S. Hard¹⁷⁶, T. Harenberg¹⁷⁸, F. Hariri¹¹⁹, S. Harkusha⁹⁵, R. D. Harrington⁴⁹, P. F. Harrison¹⁷³, F. Hartjes¹⁰⁹, N. M. Hartmann¹⁰², M. Hasegawa⁷⁰, Y. Hasegawa¹⁴², A. Hasib¹¹⁵, S. Hassani¹³⁸, S. Haug¹⁸, R. Hauser⁹³, L. Hauswald⁴⁷, M. Havranek¹²⁹, C. M. Hawkes¹⁹, R. J. Hawkins³², D. Hayakawa¹⁵⁹, D. Hayden⁹³, C. P. Hays¹²², J. M. Hays⁷⁹, H. S. Hayward⁷⁷, S. J. Haywood¹³³, S. J. Head¹⁹, T. Heck⁸⁶, V. Hedberg⁸⁴, L. Heelan⁸, S. Heim¹²⁴, T. Heim¹⁶, B. Heinemann¹⁶, J. J. Heinrich¹⁰², L. Heinrich¹¹², C. Heinz⁵⁵, J. Hejbal¹²⁹, L. Helary³², S. Hellman^{148a,148b}, C. Hensens³², J. Henderson¹²², R. C. W. Henderson⁷⁵, Y. Heng¹⁷⁶, S. Henkelmann¹⁷¹, A. M. Henriques Correia³², S. Henrot-Versille¹¹⁹, G. H. Herbert¹⁷, H. Herde²⁵, V. Herget¹⁷⁷, Y. Hernández Jiménez^{147c}, G. Herten⁵¹, R. Hertenberger¹⁰², L. Hervas³², G. G. Hesketh⁸¹, N. P. Hessey¹⁰⁹, J. W. Hetherly⁴³, E. Higón-Rodríguez¹⁷⁰, E. Hill¹⁷², J. C. Hill³⁰, K. H. Hiller⁴⁵, S. J. Hillier¹⁹, I. Hinchliffe¹⁶, E. Hines¹²⁴, M. Hirose⁵¹, D. Hirschbuehl¹⁷⁸, X. Hoad⁴⁹, J. Hobbs¹⁵⁰, N. Hod^{163a}, M. C. Hodgkinson¹⁴¹, P. Hodgson¹⁴¹, A. Hoecker³², M. R. Hoferkamp¹⁰⁷, F. Hoenic¹⁰², D. Hohn²³, T. R. Holmes¹⁶, M. Homann⁴⁶, T. Honda⁶⁹, T. M. Hong¹²⁷, B. H. Hoerberman¹⁶⁹, W. H. Hopkins¹¹⁸, Y. Horii¹⁰⁵, A. J. Horton¹⁴⁴, J.-Y. Hostachy⁵⁸, S. Hou¹⁵³, A. Hoummada^{137a}, J. Howarth⁴⁵, J. Hoya⁷⁴, M. Hrabovsky¹¹⁷, I. Hristova¹⁷, J. Hrivnac¹¹⁹, T. Hryn'ova⁵, A. Hrynevich⁹⁶, P. J. Hsu⁶³, S.-C. Hsu¹⁴⁰, Q. Hu^{36a}, S. Hu^{36c}, Y. Huang⁴⁵, Z. Hubacek¹³⁰, F. Hubaut⁸⁸, F. Huegging²³, T. B. Huffman¹²², E. W. Hughes³⁸, G. Hughes⁷⁵, M. Huhtinen³², P. Huo¹⁵⁰, N. Huseynov^{68,b}, J. Huston⁹³, J. Huth⁵⁹, G. Iacobucci⁵², G. Iakovidis²⁷, I. Ibragimov¹⁴³, L. Iconomidou-Fayard¹¹⁹, E. Ideal¹⁷⁹, Z. Idrissi^{137e}, P. Inengo³², O. Igonkina^{109,u}

T. Iizawa¹⁷⁴, T. Ikai¹⁷⁴, Y. Ikegami⁶⁹, M. Ikeno⁶⁹, Y. Ilchenko^{11,v}, D. Iliadis¹⁵⁶, N. Ilic¹⁴⁵, G. Introzzi^{123a,123b}, P. Ioannou^{9,*}, M. Iodice^{136a}, K. Iordanidou³⁸, V. Ippolito⁵⁹, N. Ishijima¹²⁰, M. Ishino¹⁵⁷, M. Ishitsuka¹⁵⁹, R. Ishmukhametov¹¹³, C. Issever¹²², S. Istin^{20a}, F. Ito¹⁶⁴, J. M. Iturbe Ponce⁸⁷, R. Iuppa^{162a,162b}, W. Iwanski⁶⁵, H. Iwasaki⁶⁹, J. M. Izen⁴⁴, V. Izzo^{106a}, S. Jabbar³, B. Jackson¹²⁴, P. Jackson¹, V. Jain², K. B. Jakobi⁸⁶, K. Jakobs⁵¹, S. Jakobsen³², T. Jakoubek¹²⁹, D. O. Jamin¹¹⁶, D. K. Jana⁸², R. Jansky⁶⁵, J. Janssen²³, M. Janus⁵⁷, P. A. Janus^{41a}, G. Jarlskog⁸⁴, N. Javadov^{68,b}, T. Javůrek⁵¹, F. Jeanneau¹³⁸, L. Jeanty¹⁶, J. Jejelava^{54a,w}, G.-Y. Jeng¹⁵², D. Jennens⁹¹, P. Jenni^{51,x}, C. Jeske¹⁷³, S. Jézéquel⁵, H. Ji¹⁷⁶, J. Jia¹⁵⁰, H. Jiang⁶⁷, Y. Jiang^{36a}, Z. Jiang¹⁴⁵, S. Jiggins⁸¹, J. Jimenez Pena¹⁷⁰, S. Jin^{35a}, A. Jinaru^{28b}, O. Jinnouchi¹⁵⁹, H. Jivan^{147c}, P. Johansson¹⁴¹, K. A. Johns⁷, W. J. Johnson¹⁴⁰, K. Jon-And^{148a,148b}, G. Jones¹⁷³, R. W. L. Jones⁷⁵, S. Jones⁷, T. J. Jones⁷⁷, J. Jongmanns^{60a}, P. M. Jorge^{128a,128b}, J. Jovicevic^{163a}, X. Ju¹⁷⁶, A. Juste Rozas^{13,s}, M. K. Köhler¹⁷⁵, A. Kaczmarek⁴², M. Kado¹¹⁹, H. Kagan¹¹³, M. Kagan¹⁴⁵, S. J. Kahn⁸⁸, T. Kaji¹⁷⁴, E. Kajomovitz⁴⁸, C. W. Kalderon¹²², A. Kaluza⁸⁶, S. Kama⁴³, A. Kamenshchikov¹³², N. Kanaya¹⁵⁷, S. Kaneti³⁰, L. Kanjir⁷⁸, V. A. Kantserov¹⁰⁰, J. Kanzaki⁶⁹, B. Kaplan¹¹², L. S. Kaplan¹⁷⁶, A. Kapliy³³, D. Kar^{147c}, K. Karakostas¹⁰, A. Karamaoun³, N. Karastathis¹⁰, M. J. Kareem⁵⁷, E. Karentzos¹⁰, M. Karnevskiy⁸⁶, S. N. Karpov⁶⁸, Z. M. Karpova⁶⁸, K. Karthik¹¹², V. Kartvelishvili⁷⁵, A. N. Karyukhin¹³², K. Kasahara¹⁶⁴, L. Kashif¹⁷⁶, R. D. Kass¹¹³, A. Kastanas¹⁴⁹, Y. Kataoka¹⁵⁷, C. Kato¹⁵⁷, A. Katre⁵², J. Katzy⁴⁵, K. Kawade¹⁰⁵, K. Kawagoe⁷³, T. Kawamoto¹⁵⁷, G. Kawamura⁵⁷, V. F. Kazanin^{111,c}, R. Keeler¹⁷², R. Kehoe⁴³, J. S. Keller⁴⁵, J. J. Kempster⁸⁰, H. Keoshkerian¹⁶¹, O. Kepka¹²⁹, B. P. Kerševan⁷⁸, S. Kersten¹⁷⁸, R. A. Keyes⁹⁰, M. Khader¹⁶⁹, F. Khalil-zada¹², A. Khanov¹¹⁶, A. G. Kharlamov^{111,c}, T. Kharlamova^{111,c}, T. J. Khoo⁵², V. Khovanskiy⁹⁹, E. Khramov⁶⁸, J. Khubua^{54b,y}, S. Kido⁷⁰, C. R. Kilby⁸⁰, H. Y. Kim⁸, S. H. Kim¹⁶⁴, Y. K. Kim³³, N. Kimura¹⁵⁶, O. M. Kind¹⁷, B. T. King⁷⁷, M. King¹⁷⁰, J. Kirk¹³³, A. E. Kiryunin¹⁰³, T. Kishimoto¹⁵⁷, D. Kisiielewska^{41a}, F. Kiss⁵¹, K. Kiuchi¹⁶⁴, O. Kivernyk¹³⁸, E. Kladiva^{146b}, M. H. Klein³⁸, M. Klein⁷⁷, U. Klein⁷⁷, K. Kleinknecht⁸⁶, P. Klimek¹¹⁰, A. Klimentov²⁷, R. Klingenberg⁴⁶, T. Klioutchnikova³², E.-E. Kluge^{60a}, P. Kluit¹⁰⁹, S. Kluth¹⁰³, J. Knapik⁴², E. Kneringer⁶⁵, E. B. F. G. Knoops⁸⁸, A. Knue¹⁰³, A. Kobayashi¹⁵⁷, D. Kobayashi¹⁵⁹, T. Kobayashi¹⁵⁷, M. Kobel⁴⁷, M. Kocian¹⁴⁵, P. Kodys¹³¹, T. Koffas³¹, E. Koffeman¹⁰⁹, N. M. Köhler¹⁰³, T. Koi¹⁴⁵, H. Kolanoski¹⁷, M. Kolb^{60b}, I. Koletsou⁵, A. A. Komar^{98,*}, Y. Komori¹⁵⁷, T. Kondo⁶⁹, N. Kondrashova^{36c}, K. Köneke⁵¹, A. C. König¹⁰⁸, T. Kono^{69,z}, R. Konoplich^{112,aa}, N. Konstantinidis⁸¹, R. Kopeliansky⁶⁴, S. Koperny^{41a}, L. Köpke⁸⁶, A. K. Kopp⁵¹, K. Korcyl⁴², K. Kordas¹⁵⁶, A. Korn⁸¹, A. A. Korol^{111,c}, I. Korolkov¹³, E. V. Korolkova¹⁴¹, O. Kortner¹⁰³, S. Kortner¹⁰³, T. Kosek¹³¹, V. V. Kostyukhin²³, A. Kotwal⁴⁸, A. Koulouris¹⁰, A. Kourkoumeli-Charalampidi^{123a,123b}, C. Kourkoumelis⁹, V. Kouskoura²⁷, A. B. Kowalewska⁴², R. Kowalewski¹⁷², T. Z. Kowalski^{41a}, C. Kozakai¹⁵⁷, W. Kozanecki¹³⁸, A. S. Kozhin¹³², V. A. Kramarenko¹⁰¹, G. Kramberger⁷⁸, D. Krasnopevtsev¹⁰⁰, M. W. Krasny⁸³, A. Krasznahorkay³², A. Kravchenko²⁷, M. Kretz^{60c}, J. Kretzschmar⁷⁷, K. Kreutzfeldt⁵⁵, P. Krieger¹⁶¹, K. Krizka³³, K. Kroeninger⁴⁶, H. Kroha¹⁰³, J. Kroll¹²⁴, J. Kroseberg²³, J. Krstic¹⁴, U. Kruchonak⁶⁸, H. Krüger²³, N. Krumnack⁶⁷, M. C. Kruse⁴⁸, M. Kruskal²⁴, T. Kubota⁹¹, H. Kucuk⁸¹, S. Kuday^{4b}, J. T. Kuechler¹⁷⁸, S. Kuehn⁵¹, A. Kugel^{60c}, F. Kuger¹⁷⁷, T. Kuhl⁴⁵, V. Kukhtin⁶⁸, R. Kukla¹³⁸, Y. Kulchitsky⁹⁵, S. Kuleshov^{34b}, M. Kuna^{134a,134b}, T. Kunigo⁷¹, A. Kupco¹²⁹, H. Kurashige⁷⁰, L. L. Kurchaninov^{163a}, Y. A. Kurochkin⁹⁵, M. G. Kurth⁴⁴, V. Kus¹²⁹, E. S. Kuwertz¹⁷², M. Kuze¹⁵⁹, J. Kvita¹¹⁷, T. Kwan¹⁷², D. Kyriazopoulos¹⁴¹, A. La Rosa¹⁰³, J. L. La Rosa Navarro^{26d}, L. La Rotonda^{40a,40b}, C. Lacasta¹⁷⁰, F. Lacava^{134a,134b}, J. Lacey³¹, H. Lacker¹⁷, D. Lacour⁸³, V. R. Lacuesta¹⁷⁰, E. Ladygin⁶⁸, R. Lafaye⁵, B. Laforge⁸³, T. Lagouri¹⁷⁹, S. Lai⁵⁷, S. Lammers⁶⁴, W. Lampl⁷, E. Lançon¹³⁸, U. Landgraf⁵¹, M. P. J. Landon⁷⁹, M. C. Lanfermann⁵², V. S. Lang^{60a}, J. C. Lange¹³, A. J. Lankford¹⁶⁶, F. Lanni²⁷, K. Lantzsch²³, A. Lanza^{123a}, S. Laplace⁸³, C. Lapoire³², J. F. Laporte¹³⁸, T. Lari^{94a}, F. Lasagni Manghi^{22a,22b}, M. Lassnig³², P. Laurelli⁵⁰, W. Lavrijsen¹⁶, A. T. Law¹³⁹, P. Laycock⁷⁷, T. Lazovich⁵⁹, M. Lazzaroni^{94a,94b}, B. Le⁹¹, O. Le Dortz⁸³, E. Le Guirriec⁸⁸, E. P. Le Quilleuc¹³⁸, M. LeBlanc¹⁷², T. LeCompte⁶, F. Ledroit-Guillon⁵⁸, C. A. Lee²⁷, S. C. Lee¹⁵³, L. Lee¹, B. Lefebvre⁹⁰, G. Lefebvre⁸³, M. Lefebvre¹⁷², F. Legger¹⁰², C. Leggett¹⁶, A. Lehan⁷⁷, G. Lehmann Miotto³², X. Lei⁷, W. A. Leight³¹, A. G. Leister¹⁷⁹, M. A. L. Leite^{26d}, R. Leitner¹³¹, D. Lellouch¹⁷⁵, B. Lemmer⁵⁷, K. J. C. Leney⁸¹, T. Lenz²³, B. Lenzi³², R. Leone⁷, S. Leone^{126a,126b}, C. Leonidopoulos⁴⁹, S. Leontsinis¹⁰, G. Lerner¹⁵¹, C. Leroy⁹⁷, A. A. J. Lesage¹³⁸, C. G. Lester³⁰, M. Levchenko¹²⁵, J. Levêque⁵, D. Levin⁹², L. J. Levinson¹⁷⁵, M. Levy¹⁹, D. Lewis⁷⁹, M. Leyton⁴⁴, B. Li^{36a,p}, C. Li^{36a}, H. Li¹⁵⁰, L. Li⁴⁸, L. Li^{36c}, Q. Li^{35a}, S. Li⁴⁸, X. Li⁸⁷, Y. Li¹⁴³, Z. Liang^{35a}, B. Liberti^{135a}, A. Liblong¹⁶¹, P. Lichard³², K. Lie¹⁶⁹, J. Liebal²³, W. Liebig¹⁵, A. Limosani¹⁵², S. C. Lin^{153,ab}, T. H. Lin⁸⁶, B. E. Lindquist¹⁵⁰, A. E. Lioni⁵², E. Lipeles¹²⁴, A. Lipniacka¹⁵, M. Lisovyi^{60b}, T. M. Liss¹⁶⁹, A. Lister¹⁷¹, A. M. Litke¹³⁹, B. Liu^{153,ac}, D. Liu¹⁵³, H. Liu⁹², H. Liu²⁷, J. Liu^{36b}, J. B. Liu^{36a}, K. Liu⁸⁸, L. Liu¹⁶⁹, M. Liu^{36a}, Y. L. Liu^{36a}, Y. Liu^{36a}, M. Livan^{123a,123b}, A. Lleres⁵⁸, J. Llorente Merino^{35a}, S. L. Lloyd⁷⁹, F. Lo Sterzo¹⁵³, E. M. Lobodzinska⁴⁵, P. Loch⁷, F. K. Loebinger⁸⁷, K. M. Loew²⁵, A. Loginov^{179,*}, T. Lohse¹⁷, K. Lohwasser⁴⁵, M. Lokajicek¹²⁹, B. A. Long²⁴, J. D. Long¹⁶⁹, R. E. Long⁷⁵, L. Longo^{76a,76b}, K. A. Looper¹¹³, J. A. Lopez Lopez^{34b}, D. Lopez Mateos⁵⁹, B. Lopez Paredes¹⁴¹, I. Lopez Paz¹³, A. Lopez Solis⁸³, J. Lorenz¹⁰², N. Lorenzo Martinez⁶⁴, M. Losada²¹, P. J. Lösel¹⁰², X. Lou^{35a}, A. Lounis¹¹⁹, J. Love⁶, P. A. Love⁷⁵, H. Lu^{62a},

N. Lu⁹², H. J. Lubatti¹⁴⁰, C. Luci^{134a,134b}, A. Lucotte⁵⁸, C. Luedtke⁵¹, F. Luehring⁶⁴, W. Lukas⁶⁵, L. Luminari^{134a}, O. Lundberg^{148a,148b}, B. Lund-Jensen¹⁴⁹, P. M. Luzzi⁸³, D. Lynn²⁷, R. Lysak¹²⁹, E. Lytken⁸⁴, V. Lyubushkin⁶⁸, H. Ma²⁷, L. L. Ma^{36b}, Y. Ma^{36b}, G. Maccarrone⁵⁰, A. Macchiolo¹⁰³, C. M. Macdonald¹⁴¹, B. Maček⁷⁸, J. Machado Miguens^{124,128b}, D. Madaffari⁸⁸, R. Madar³⁷, H. J. Maddocks¹⁶⁸, W. F. Mader⁴⁷, A. Madsen⁴⁵, J. Maeda⁷⁰, S. Maeland¹⁵, T. Maeno²⁷, A. Maeviskiy¹⁰¹, E. Magradze⁵⁷, J. Mahlstedt¹⁰⁹, C. Maiani¹¹⁹, C. Maidantchik^{26a}, A. A. Maier¹⁰³, T. Maier¹⁰², A. Maio^{128a,128b,128d}, S. Majewski¹¹⁸, Y. Makida⁶⁹, N. Makovec¹¹⁹, B. Malaescu⁸³, Pa. Malecki⁴², V. P. Maleev¹²⁵, F. Malek⁵⁸, U. Mallik⁶⁶, D. Malon⁶, C. Malone¹⁴⁵, C. Malone³⁰, S. Maltezos¹⁰, S. Malyukov³², J. Mamuzic¹⁷⁰, G. Mancini⁵⁰, L. Mandelli^{94a}, I. Mandić⁷⁸, J. Maneira^{128a,128b}, L. Manhaes de Andrade Filho^{26b}, J. Manjarres Ramos^{163b}, A. Mann¹⁰², A. Manousos³², B. Mansoulie¹³⁸, J. D. Mansour^{35a}, R. Mantifel⁹⁰, M. Mantoani⁵⁷, S. Manzoni^{94a,94b}, L. Mapelli³², G. Marceca²⁹, L. March⁵², G. Marchiori⁸³, M. Marcisovsky¹²⁹, M. Marjanovic¹⁴, D. E. Marley⁹², F. Marroquim^{26a}, S. P. Marsden⁸⁷, Z. Marshall¹⁶, S. Marti-Garcia¹⁷⁰, B. Martin⁹³, T. A. Martin¹⁷³, V. J. Martin⁴⁹, B. Martin dit Latour¹⁵, M. Martinez^{13,s}, V. I. Martinez Outschoorn¹⁶⁹, S. Martin-Haugh¹³³, V. S. Martoiu^{28b}, A. C. Martyniuk⁸¹, A. Marzin³², L. Masetti⁸⁶, T. Mashimo¹⁵⁷, R. Mashinistov⁹⁸, J. Masik⁸⁷, A. L. Maslennikov^{111,c}, I. Massa^{22a,22b}, L. Massa^{22a,22b}, P. Mastrandrea⁵, A. Mastroberardino^{40a,40b}, T. Masubuchi¹⁵⁷, P. Mättig¹⁷⁸, J. Mattmann⁸⁶, J. Maurer^{28b}, S. J. Maxfield⁷⁷, D. A. Maximov^{111,c}, R. Mazini¹⁵³, I. Maznas¹⁵⁶, S. M. Mazza^{94a,94b}, N. C. Mc Fadden¹⁰⁷, G. Mc Goldrick¹⁶¹, S. P. Mc Kee⁹², A. McCam⁹², R. L. McCarthy¹⁵⁰, T. G. McCarthy¹⁰³, L. I. McClymont⁸¹, E. F. McDonald⁹¹, J. A. McFayden⁸¹, G. Mchedlidze⁵⁷, S. J. McMahon¹³³, P. C. McNamara⁹¹, R. A. McPherson^{172,m}, M. Medinnis⁴⁵, S. Meehan¹⁴⁰, S. Mehlhase¹⁰², A. Mehta⁷⁷, K. Meier^{60a}, C. Meineck¹⁰², B. Meirose⁴⁴, D. Melini¹⁷⁰, B. R. Mellado Garcia^{147c}, M. Melo^{146a}, F. Meloni¹⁸, S. B. Menary⁸⁷, L. Meng⁷⁷, X. T. Meng⁹², A. Mengarelli^{22a,22b}, S. Menke¹⁰³, E. Meoni¹⁶⁵, S. Mergelmeyer¹⁷, P. Mermod⁵², L. Merola^{106a,106b}, C. Meroni^{94a}, F. S. Merritt³³, A. Messina^{134a,134b}, J. Metcalfe⁶, A. S. Mete¹⁶⁶, C. Meyer⁸⁶, C. Meyer¹²⁴, J.-P. Meyer¹³⁸, J. Meyer¹⁰⁹, H. Meyer Zu Theenhausen^{60a}, F. Miano¹⁵¹, R. P. Middleton¹³³, S. Miglioranza^{53a,53b}, L. Mijovic⁴⁹, G. Mikenberg¹⁷⁵, M. Mikestikova¹²⁹, M. Mikuz⁷⁸, M. Milesi⁹¹, A. Milic²⁷, D. W. Miller³³, C. Mills⁴⁹, A. Milov¹⁷⁵, D. A. Milstead^{148a,148b}, A. A. Minaenko¹³², Y. Minami¹⁵⁷, I. A. Minashvili⁶⁸, A. I. Mincer¹¹², B. Mindur^{41a}, M. Mineev⁶⁸, Y. Minegishi¹⁵⁷, Y. Ming¹⁷⁶, L. M. Mir¹³, K. P. Mistry¹²⁴, T. Mitani¹⁷⁴, J. Mitrevski¹⁰², V. A. Mitsou¹⁷⁰, A. Miucci¹⁸, P. S. Miyagawa¹⁴¹, A. Mizukami⁶⁹, J. U. Mjörnmark⁸⁴, M. Mlynarikova¹³¹, T. Moa^{148a,148b}, K. Mochizuki⁹⁷, P. Mogg⁵¹, S. Mohapatra³⁸, S. Molander^{148a,148b}, R. Moles-Valls²³, R. Monden⁷¹, M. C. Mondragon⁹³, K. Mönig⁴⁵, J. Monk³⁹, E. Monnier⁸⁸, A. Montalbano¹⁵⁰, J. Montejo Berlingen³², F. Monticelli⁷⁴, S. Monzani^{94a,94b}, R. W. Moore³, N. Morange¹¹⁹, D. Moreno²¹, M. Moreno Llácer⁵⁷, P. Morettini^{53a}, S. Morgenstern³², D. Mori¹⁴⁴, T. Mori¹⁵⁷, M. Morii⁵⁹, M. Morinaga¹⁵⁷, V. Morisbak¹²¹, S. Moritz⁸⁶, A. K. Morley¹⁵², G. Mornacchi³², J. D. Morris⁷⁹, S. S. Mortensen³⁹, L. Morvaj¹⁵⁰, P. Moschovakos¹⁰, M. Mosidze^{54b}, H. J. Moss¹⁴¹, J. Moss^{145,ad}, K. Motohashi¹⁵⁹, R. Mount¹⁴⁵, E. Mountricha²⁷, E. J. W. Moyse⁸⁹, S. Muanza⁸⁸, R. D. Mudd¹⁹, F. Mueller¹⁰³, J. Mueller¹²⁷, R. S. P. Mueller¹⁰², T. Mueller³⁰, D. Muenstermann⁷⁵, P. Mullen⁵⁶, G. A. Mullier¹⁸, F. J. Munoz Sanchez⁸⁷, J. A. Murillo Quijada¹⁹, W. J. Murray^{173,133}, H. Musheghyan⁵⁷, M. Muškinja⁷⁸, A. G. Myagkov^{132,ae}, M. Myska¹³⁰, B. P. Nachman¹⁴⁵, O. Nackenhorst⁵², K. Nagai¹²², R. Nagai^{69,z}, K. Nagano⁶⁹, Y. Nagasaka⁶¹, K. Nagata¹⁶⁴, M. Nagel⁵¹, E. Nagy⁸⁸, A. M. Nairz³², Y. Nakahama¹⁰⁵, K. Nakamura⁶⁹, T. Nakamura¹⁵⁷, I. Nakano¹¹⁴, R. F. Naranjo Garcia⁴⁵, R. Narayan¹¹, D. I. Narrias Villar^{60a}, I. Naryshkin¹²⁵, T. Naumann⁴⁵, G. Navarro²¹, R. Nayyar⁷, H. A. Neal⁹², P. Yu. Nechaeva⁹⁸, T. J. Neep⁸⁷, A. Negri^{123a,123b}, M. Negrini^{22a}, S. Nektarijevic¹⁰⁸, C. Nellist¹¹⁹, A. Nelson¹⁶⁶, S. Nemecek¹²⁹, P. Nemethy¹¹², A. A. Nepomuceno^{26a}, M. Nessi^{32,af}, M. S. Neubauer¹⁶⁹, M. Neumann¹⁷⁸, R. M. Neves¹¹², P. Nevski²⁷, P. R. Newman¹⁹, D. H. Nguyen⁶, T. Nguyen Manh⁹⁷, R. B. Nickerson¹²², R. Nicolaidou¹³⁸, J. Nielsen¹³⁹, A. Nikiforov¹⁷, V. Nikolaenko^{132,ae}, I. Nikolic-Audit⁸³, K. Nikolopoulos¹⁹, J. K. Nilsen¹²¹, P. Nilsson²⁷, Y. Ninomiya¹⁵⁷, A. Nisati^{134a}, R. Nisius¹⁰³, T. Nobe¹⁵⁷, M. Nomachi¹²⁰, I. Nomidis³¹, T. Nooney⁷⁹, S. Norberg¹¹⁵, M. Nordberg³², N. Norjoharuddeen¹²², O. Novgorodova⁴⁷, S. Nowak¹⁰³, M. Nozaki⁶⁹, L. Nozka¹¹⁷, K. Ntekas¹⁶⁶, E. Nurse⁸¹, F. Nuti⁹¹, F. O'grady⁷, D. C. O'Neil¹⁴⁴, A. A. O'Rourke⁴⁵, V. O'Shea⁵⁶, F. G. Oakham^{31,d}, H. Oberlack¹⁰³, T. Obermann²³, J. Ocariz⁸³, A. Ochi⁷⁰, I. Ochoa³⁸, J. P. Ochoa-Ricoux^{34a}, S. Oda⁷³, S. Odaka⁶⁹, H. Ogren⁶⁴, A. Oh⁸⁷, S. H. Oh⁴⁸, C. C. Ohm¹⁶, H. Ohman¹⁶⁸, H. Oide^{53a,53b}, H. Okawa¹⁶⁴, Y. Okumura¹⁵⁷, T. Okuyama⁶⁹, A. Olariu^{28b}, L. F. Oleiro Seabra^{128a}, S. A. Olivares Pino⁴⁹, D. Oliveira Damazio²⁷, A. Olszewski⁴², J. Olszowska⁴², A. Onofre^{128a,128e}, K. Onogi¹⁰⁵, P. U. E. Onyisi^{11,v}, M. J. Oreglia³³, Y. Oren¹⁵⁵, D. Orestano^{136a,136b}, N. Orlando^{62b}, R. S. Orr¹⁶¹, B. Osculati^{53a,53b,*}, R. Ospanov⁸⁷, G. Otero y Garzon²⁹, H. Otono⁷³, M. Ouchrif^{137d}, F. Ould-Saada¹²¹, A. Ouraou¹³⁸, K. P. Oussoren¹⁰⁹, Q. Ouyang^{35a}, M. Owen⁵⁶, R. E. Owen¹⁹, V. E. Ozcan^{20a}, N. Ozturk⁸, K. Pachal¹⁴⁴, A. Pacheco Pages¹³, L. Pacheco Rodriguez¹³⁸, C. Padilla Aranda¹³, M. Pagáčová⁵¹, S. Pagan Griso¹⁶, M. Paganini¹⁷⁹, F. Paige²⁷, P. Pais⁸⁹, K. Pajchel¹²¹, G. Palacino⁶⁴, S. Palazzo^{40a,40b}, S. Palestini³², M. Palka^{41b}, D. Pallin³⁷, E. St. Panagiotopoulou¹⁰, I. Panagoulas¹⁰, C. E. Pandini⁸³, J. G. Panduro Vazquez⁸⁰, P. Pani^{148a,148b}, S. Panitkin²⁷,

D. Pantea^{28b}, L. Paolozzi⁵², Th. D. Papadopoulou¹⁰, K. Papageorgiou¹⁵⁶, A. Paramonov⁶, D. Paredes Hernandez¹⁷⁹, A. J. Parker⁷⁵, M. A. Parker³⁰, K. A. Parker¹⁴¹, F. Parodi^{53a,53b}, J. A. Parsons³⁸, U. Parzefall⁵¹, V. R. Pascuzzi¹⁶¹, E. Pasqualucci^{134a}, S. Passaggio^{53a}, Fr. Pastore⁸⁰, G. Pásztor^{31.ag}, S. Patariaia¹⁷⁸, J. R. Pater⁸⁷, T. Pauly³², J. Pearce¹⁷², B. Pearson¹¹⁵, L. E. Pedersen³⁹, M. Pedersen¹²¹, S. Pedraza Lopez¹⁷⁰, R. Pedro^{128a,128b}, S. V. Peleganchuk^{111.c}, O. Penc¹²⁹, C. Peng^{35a}, H. Peng^{36a}, J. Penwell⁶⁴, B. S. Peralva^{26b}, M. M. Perego¹³⁸, D. V. Perepelitsa²⁷, E. Perez Codina^{163a}, L. Perini^{94a,94b}, H. Pernegger³², S. Perrella^{106a,106b}, R. Peschke⁴⁵, V. D. Peshekhonov⁶⁸, K. Peters⁴⁵, R. F. Y. Peters⁸⁷, B. A. Petersen³², T. C. Petersen³⁹, E. Petit⁵⁸, A. Petridis¹, C. Petridou¹⁵⁶, P. Petroff¹¹⁹, E. Petrolo^{134a}, M. Petrov¹²², F. Petrucci^{136a,136b}, N. E. Pettersson⁸⁹, A. Peyaud¹³⁸, R. Pezoa^{34b}, P. W. Phillips¹³³, G. Piacquadio^{145.ah}, E. Pianori¹⁷³, A. Picazio⁸⁹, E. Piccaro⁷⁹, M. Piccinini^{22a,22b}, M. A. Pickering¹²², R. Piegai²⁹, J. E. Pilcher³³, A. D. Pilkington⁸⁷, A. W. J. Pin⁸⁷, M. Pinamonti^{167a,167c.ai}, J. L. Pinfold³, A. Pingel³⁹, S. Pires⁸³, H. Pirumov⁴⁵, M. Pitt¹⁷⁵, L. Plazak^{146a}, M.-A. Pleier²⁷, V. Pleskot⁸⁶, E. Plotnikova⁶⁸, D. Pluth⁶⁷, R. Poettgen^{148a,148b}, L. Poggioli¹¹⁹, D. Pohl²³, G. Polesello^{123a}, A. Poley⁴⁵, A. Policicchio^{40a,40b}, R. Polifka¹⁶¹, A. Polini^{22a}, C. S. Pollard⁵⁶, V. Polychronakos²⁷, K. Pommès³², L. Pontecorvo^{134a}, B. G. Pope⁹³, G. A. Popeneciu^{28c}, A. Poppleton³², S. Pospisil¹³⁰, K. Potamianos¹⁶, I. N. Potrap⁶⁸, C. J. Potter³⁰, C. T. Potter¹¹⁸, G. Poulard³², J. Poveda³², V. Pozdnyakov⁶⁸, M. E. Pozo Astigarraga³², P. Pralavorio⁸⁸, A. Pranko¹⁶, S. Prell⁶⁷, D. Price⁸⁷, L. E. Price⁶, M. Primavera^{76a}, S. Prince⁹⁰, K. Prokofiev^{62c}, F. Prokoshin^{34b}, S. Protopopescu²⁷, J. Proudfoot⁶, M. Przybycien^{41a}, D. Puddu^{136a,136b}, M. Purohit^{27.aj}, P. Puzo¹¹⁹, J. Qian⁹², G. Qin⁵⁶, Y. Qin⁸⁷, A. Quadt⁵⁷, W. B. Quayle^{167a,167b}, M. Queitsch-Maitland⁴⁵, D. Quilty⁵⁶, S. Raddum¹²¹, V. Radeka²⁷, V. Radescu¹²², S. K. Radhakrishnan¹⁵⁰, P. Radloff¹¹⁸, P. Rados⁹¹, F. Ragusa^{94a,94b}, G. Rahal¹⁸¹, J. A. Raine⁸⁷, S. Rajagopalan²⁷, M. Rammensee³², C. Rangel-Smith¹⁶⁸, M. G. Ratti^{94a,94b}, D. M. Rauch⁴⁵, F. Rauscher¹⁰², S. Rave⁸⁶, T. Ravenscroft⁵⁶, I. Ravinovich¹⁷⁵, M. Raymond³², A. L. Read¹²¹, N. P. Readioff⁷⁷, M. Reale^{76a,76b}, D. M. Rebuzzi^{123a,123b}, A. Redelbach¹⁷⁷, G. Redlinger²⁷, R. Reece¹³⁹, R. G. Reed^{147c}, K. Reeves⁴⁴, L. Rehnisch¹⁷, J. Reichert¹²⁴, A. Reiss⁸⁶, C. Rembser³², H. Ren^{35a}, M. Rescigno^{134a}, S. Resconi^{94a}, O. L. Rezanova^{111.c}, P. Reznicek¹³¹, R. Rezvani⁹⁷, R. Richter¹⁰³, S. Richter⁸¹, E. Richter-Was^{41b}, O. Ricken²³, M. Ridel⁸³, P. Rieck¹⁷, C. J. Riegel¹⁷⁸, J. Rieger⁵⁷, O. Rifki¹¹⁵, M. Rijssenbeek¹⁵⁰, A. Rimoldi^{123a,123b}, M. Rimoldi¹⁸, L. Rinaldi^{22a}, B. Ristić⁵², E. Ritsch³², I. Riu¹³, F. Rizatdinova¹¹⁶, E. Rizvi⁷⁹, C. Rizzi¹³, S. H. Robertson^{90.m}, A. Robichaud-Veronneau⁹⁰, D. Robinson³⁰, J. E. M. Robinson⁴⁵, A. Robson⁵⁶, C. Roda^{126a,126b}, Y. Rodina^{88.ak}, A. Rodriguez Perez¹³, D. Rodriguez Rodriguez¹⁷⁰, S. Roe³², C. S. Rogan⁵⁹, O. Røhne¹²¹, J. Roloff⁵⁹, A. Romaniouk¹⁰⁰, M. Romano^{22a,22b}, S. M. Romano Saez³⁷, E. Romero Adam¹⁷⁰, N. Rompotis¹⁴⁰, M. Ronzani⁵¹, L. Roos⁸³, E. Ros¹⁷⁰, S. Rosati^{134a}, K. Rosbach⁵¹, P. Rose¹³⁹, N.-A. Rosien⁵⁷, V. Rossetti^{148a,148b}, E. Rossi^{106a,106b}, L. P. Rossi^{53a}, J. H. N. Rosten³⁰, R. Rosten¹⁴⁰, M. Rotaru^{28b}, I. Roth¹⁷⁵, J. Rothberg¹⁴⁰, D. Rousseau¹¹⁹, A. Rozanov⁸⁸, Y. Rozen¹⁵⁴, X. Ruan^{147c}, F. Rubbo¹⁴⁵, M. S. Rudolph¹⁶¹, F. Rühr⁵¹, A. Ruiz-Martinez³¹, Z. Rurikova⁵¹, N. A. Rusakovich⁶⁸, A. Ruschke¹⁰², H. L. Russell¹⁴⁰, J. P. Rutherford⁷, N. Ruthmann³², Y. F. Ryabov¹²⁵, M. Rybar¹⁶⁹, G. Rybkin¹¹⁹, S. Ryu⁶, A. Ryzhov¹³², G. F. Rzehorz⁵⁷, A. F. Saavedra¹⁵², G. Sabato¹⁰⁹, S. Sacerdoti²⁹, H. F.-W. Sadrozinski¹³⁹, R. Sadykov⁶⁸, F. Safai Tehrani^{134a}, P. Saha¹¹⁰, M. Sahinsoy^{60a}, M. Saimpert¹³⁸, T. Saito¹⁵⁷, H. Sakamoto¹⁵⁷, Y. Sakurai¹⁷⁴, G. Salamanna^{136a,136b}, A. Salamon^{135a,135b}, J. E. Salazar Loyola^{34b}, D. Salek¹⁰⁹, P. H. Sales De Bruin¹⁴⁰, D. Salihagic¹⁰³, A. Salnikov¹⁴⁵, J. Salt¹⁷⁰, D. Salvatore^{40a,40b}, F. Salvatore¹⁵¹, A. Salvucci^{62a,62b,62c}, A. Salzburger³², D. Sammel⁵¹, D. Sampsonidis¹⁵⁶, J. Sánchez¹⁷⁰, V. Sanchez Martinez¹⁷⁰, A. Sanchez Pineda^{106a,106b}, H. Sandaker¹²¹, R. L. Sandbach⁷⁹, M. Sandhoff¹⁷⁸, C. Sandoval²¹, D. P. C. Sankey¹³³, M. Sannino^{53a,53b}, A. Sansoni⁵⁰, C. Santoni³⁷, R. Santonico^{135a,135b}, H. Santos^{128a}, I. Santoyo Castillo¹⁵¹, K. Sapp¹²⁷, A. Sapronov⁶⁸, J. G. Saraiva^{128a,128d}, B. Sarrazin²³, O. Sasaki⁶⁹, K. Sato¹⁶⁴, E. Sauvan⁵, G. Savage⁸⁰, P. Savard^{161.d}, N. Savic¹⁰³, C. Sawyer¹³³, L. Sawyer^{82.r}, J. Saxon³³, C. Sbarra^{22a}, A. Sbrizzi^{22a,22b}, T. Scanlon⁸¹, D. A. Scannicchio¹⁶⁶, M. Scarcella¹⁵², V. Scarfone^{40a,40b}, J. Schaarschmidt¹⁷⁵, P. Schacht¹⁰³, B. M. Schachtner¹⁰², D. Schaefer³², L. Schaefer¹²⁴, R. Schaefer⁴⁵, J. Schaeffer⁸⁶, S. Schaepe²³, S. Schaezel^{60b}, U. Schäfer⁸⁶, A. C. Schaffer¹¹⁹, D. Schaile¹⁰², R. D. Schamberger¹⁵⁰, V. Scharf^{60a}, V. A. Schegelsky¹²⁵, D. Scheirich¹³¹, M. Schernau¹⁶⁶, C. Schiavi^{53a,53b}, S. Schier¹³⁹, C. Schillo⁵¹, M. Schioppa^{40a,40b}, S. Schlenker³², K. R. Schmidt-Sommerfeld¹⁰³, K. Schmieden³², C. Schmitt⁸⁶, S. Schmitt⁴⁵, S. Schmitz⁸⁶, B. Schneider^{163a}, U. Schnoor⁵¹, L. Schoeffel¹³⁸, A. Schoening^{60b}, B. D. Schoenrock⁹³, E. Schopf²³, M. Schott⁸⁶, J. F. P. Schouwenberg¹⁰⁸, J. Schovancova⁸, S. Schramm⁵², M. Schreyer¹⁷⁷, N. Schuh⁸⁶, A. Schulte⁸⁶, M. J. Schultens²³, H.-C. Schultz-Coulon^{60a}, H. Schulz¹⁷, M. Schumacher⁵¹, B. A. Schumm¹³⁹, Ph. Schune¹³⁸, A. Schwartzman¹⁴⁵, T. A. Schwarz⁹², H. Schweiger⁸⁷, Ph. Schwemling¹³⁸, R. Schwienhorst⁹³, J. Schwindling¹³⁸, T. Schwindt²³, G. Sciolla²⁵, F. Scuri^{126a,126b}, F. Scutti⁹¹, J. Searcy⁹², P. Seema²³, S. C. Seidel¹⁰⁷, A. Seiden¹³⁹, F. Seifert¹³⁰, J. M. Seixas^{26a}, G. Sekhniaidze^{106a}, K. Sekhon⁹², S. J. Sekula⁴³, D. M. Seliverstov^{125.*}, N. Semprini-Cesari^{22a,22b}, C. Serfon¹²¹, L. Serin¹¹⁹, L. Serkin^{167a,167b}, M. Sessa^{136a,136b}, R. Seuster¹⁷², H. Severini¹¹⁵, T. Sfiligoi⁷⁸, F. Sforza³², A. Sfyrta⁵², E. Shabalina⁵⁷, N. W. Shaikh^{148a,148b}, L. Y. Shan^{35a}, R. Shang¹⁶⁹, J. T. Shank²⁴, M. Shapiro¹⁶, P. B. Shatalov⁹⁹, K. Shaw^{167a,167b}, S. M. Shaw⁸⁷, A. Shcherbakova^{148a,148b}, C. Y. Shehu¹⁵¹, P. Sherwood⁸¹,

L. Shi^{153,al}, S. Shimizu⁷⁰, C. O. Shimmin¹⁶⁶, M. Shimojima¹⁰⁴, S. Shirabe⁷³, M. Shiyakova^{68,am}, A. Shmeleva⁹⁸, D. Shoaleh Saadi⁹⁷, M. J. Shochet³³, S. Shojaii^{94a}, D. R. Shope¹¹⁵, S. Shrestha¹¹³, E. Shulga¹⁰⁰, M. A. Shupe⁷, P. Sicho¹²⁹, A. M. Sickles¹⁶⁹, P. E. Sidebo¹⁴⁹, E. Sideras Haddad^{147c}, O. Sidiropoulou¹⁷⁷, D. Sidorov¹¹⁶, A. Sidoti^{22a,22b}, F. Siegert⁴⁷, Dj. Sijacki¹⁴, J. Silva^{128a,128d}, S. B. Silverstein^{148a}, V. Simak¹³⁰, Lj. Simic¹⁴, S. Simion¹¹⁹, E. Simioni⁸⁶, B. Simmons⁸¹, D. Simon³⁷, M. Simon⁸⁶, P. Sinervo¹⁶¹, N. B. Sinev¹¹⁸, M. Sioli^{22a,22b}, G. Siragusa¹⁷⁷, S. Yu. Sivoklov¹⁰¹, J. Sjölin^{148a,148b}, M. B. Skinner⁷⁵, H. P. Skottowe⁵⁹, P. Skubic¹¹⁵, M. Slater¹⁹, T. Slavicek¹³⁰, M. Slawinska¹⁰⁹, K. Sliwa¹⁶⁵, R. Slovak¹³¹, V. Smakhtin¹⁷⁵, B. H. Smart⁵, L. Smestad¹⁵, J. Smiesko^{146a}, S. Yu. Smirnov¹⁰⁰, Y. Smirnov¹⁰⁰, L. N. Smirnova^{101,an}, O. Smirnova⁸⁴, J. W. Smith⁵⁷, M. N. K. Smith³⁸, R. W. Smith³⁸, M. Smizanska⁷⁵, K. Smolek¹³⁰, A. A. Snesarev⁹⁸, I. M. Snyder¹¹⁸, S. Snyder²⁷, R. Sobie^{172,m}, F. Socher⁴⁷, A. Soffer¹⁵⁵, D. A. Soh¹⁵³, G. Sokhranyii⁷⁸, C. A. Solans Sanchez³², M. Solar¹³⁰, E. Yu. Soldatov¹⁰⁰, U. Soldevila¹⁷⁰, A. A. Solodkov¹³², A. Soloshenko⁶⁸, O. V. Solovyanov¹³², V. Solovyev¹²⁵, P. Sommer⁵¹, H. Son¹⁶⁵, H. Y. Song^{36a,ao}, A. Sood¹⁶, A. Sopczak¹³⁰, V. Sopko¹³⁰, V. Sorin¹³, D. Sosa^{60b}, C. L. Sotiropoulou^{126a,126b}, R. Soualah^{167a,167c}, A. M. Soukharev^{111,c}, D. South⁴⁵, B. C. Sowden⁸⁰, S. Spagnolo^{76a,76b}, M. Spalla^{126a,126b}, M. Spangenberg¹⁷³, F. Spanò⁸⁰, D. Sperlich¹⁷, F. Spettel¹⁰³, T. M. Spieker^{60a}, R. Spighi^{22a}, G. Spigo³², L. A. Spiller⁹¹, M. Spousta¹³¹, R. D. St. Denis^{56,*}, A. Stabile^{94a}, R. Stamen^{60a}, S. Stamm¹⁷, E. Stanecka⁴², R. W. Stanek⁶, C. Stanescu^{136a}, M. Stanescu-Bellu⁴⁵, M. M. Stanitzki⁴⁵, S. Stapnes¹²¹, E. A. Starchenko¹³², G. H. Stark³³, J. Stark⁵⁸, P. Staroba¹²⁹, P. Starovoitov^{60a}, S. Stärz³², R. Staszewski⁴², P. Steinberg²⁷, B. Stelzer¹⁴⁴, H. J. Stelzer³², O. Stelzer-Chilton^{163a}, H. Stenzel⁵⁵, G. A. Stewart⁵⁶, J. A. Stillings²³, M. C. Stockton⁹⁰, M. Stoebe⁹⁰, G. Stoicea^{28b}, P. Stolte⁵⁷, S. Stonjek¹⁰³, A. R. Stradling⁸, A. Straessner⁴⁷, M. E. Stramaglia¹⁸, J. Strandberg¹⁴⁹, S. Strandberg^{148a,148b}, A. Strandlie¹²¹, M. Strauss¹¹⁵, P. Strizenec^{146b}, R. Ströhmer¹⁷⁷, D. M. Strom¹¹⁸, R. Stroynowski⁴³, A. Strubig¹⁰⁸, S. A. Stucci²⁷, B. Stugu¹⁵, N. A. Styles⁴⁵, D. Su¹⁴⁵, J. Su¹²⁷, S. Suchek^{60a}, Y. Sugaya¹²⁰, M. Suk¹³⁰, V. V. Sulin⁹⁸, S. Sultansoy^{4c}, T. Sumida⁷¹, S. Sun⁵⁹, X. Sun^{35a}, J. E. Sundermann⁵¹, K. Suruliz¹⁵¹, C. J. E. Suster¹⁵², M. R. Sutton¹⁵¹, S. Suzuki⁶⁹, M. Svatos¹²⁹, M. Swiatlowski³³, S. P. Swift², I. Sykora^{146a}, T. Sykora¹³¹, D. Ta⁵¹, C. Taccini^{136a,136b}, K. Tackmann⁴⁵, J. Taenzer¹⁵⁵, A. Taffard¹⁶⁶, R. Tafirout^{163a}, N. Taiblum¹⁵⁵, H. Takai²⁷, R. Takashima⁷², T. Takeshita¹⁴², Y. Takubo⁶⁹, M. Talby⁸⁸, A. A. Talyshv^{111,c}, K. G. Tan⁹¹, J. Tanaka¹⁵⁷, M. Tanaka¹⁵⁹, R. Tanaka¹¹⁹, S. Tanaka⁶⁹, R. Tanioka⁷⁰, B. B. Tannenwald¹¹³, S. Tapia Araya^{34b}, S. Tapprogge⁸⁶, S. Tarem¹⁵⁴, G. F. Tartarelli^{94a}, P. Tas¹³¹, M. Tasevsky¹²⁹, T. Tashiro⁷¹, E. Tassi^{40a,40b}, A. Tavares Delgado^{128a,128b}, Y. Tayalati^{137e}, A. C. Taylor¹⁰⁷, G. N. Taylor⁹¹, P. T. E. Taylor⁹¹, W. Taylor^{163b}, F. A. Teischinger³², P. Teixeira-Dias⁸⁰, K. K. Temming⁵¹, D. Temple¹⁴⁴, H. Ten Kate³², P. K. Teng¹⁵³, J. J. Teoh¹²⁰, F. Tepel¹⁷⁸, S. Terada⁶⁹, K. Terashi¹⁵⁷, J. Terron⁸⁵, S. Terzo¹³, M. Testa⁵⁰, R. J. Teuscher^{161,m}, T. Theveneaux-Pelzer⁸⁸, J. P. Thomas¹⁹, J. Thomas-Wilsker⁸⁰, P. D. Thompson¹⁹, A. S. Thompson⁵⁶, L. A. Thomsen¹⁷⁹, E. Thomson¹²⁴, M. J. Tibbetts¹⁶, R. E. Ticse Torres⁸⁸, V. O. Tikhomirov^{98,ap}, Yu. A. Tikhonov^{111,c}, S. Timoshenko¹⁰⁰, P. Tipton¹⁷⁹, S. Tisserant⁸⁸, K. Todome¹⁵⁹, T. Todorov^{5,*}, S. Todorova-Nova¹³¹, J. Tojo⁷³, S. Tokár^{146a}, K. Tokushuku⁶⁹, E. Tolley⁵⁹, L. Tomlinson⁸⁷, M. Tomoto¹⁰⁵, L. Tompkins^{145,aq}, K. Toms¹⁰⁷, B. Tong⁵⁹, P. Tornambe⁵¹, E. Torrence¹¹⁸, H. Torres¹⁴⁴, E. Torró Pastor¹⁴⁰, J. Toth^{88,ar}, F. Touchard⁸⁸, D. R. Tovey¹⁴¹, T. Trefzger¹⁷⁷, A. Tricoli²⁷, I. M. Trigger^{163a}, S. Trincaz-Duvoid⁸³, M. F. Tripiana¹³, W. Trischuk¹⁶¹, B. Trocmé⁵⁸, A. Trofymov⁴⁵, C. Troncon^{94a}, M. Trotter-McDonald¹⁶, M. Trovatelli¹⁷², L. Truong^{167a,167c}, M. Trzebinski⁴², A. Trzupek⁴², J. C.-L. Tseng¹²², P. V. Tsiarshka⁹⁵, G. Tsipolitis¹⁰, N. Tsirintanis⁹, S. Tsiskaridze¹³, V. Tsiskaridze⁵¹, E. G. Tskhadadze^{54a}, K. M. Tsui^{62a}, I. I. Tsukerman⁹⁹, V. Tsulaia¹⁶, S. Tsuno⁶⁹, D. Tsybychev¹⁵⁰, Y. Tu^{62b}, A. Tudorache^{28b}, V. Tudorache^{28b}, T. T. Tulbure^{28a}, A. N. Tuna⁵⁹, S. A. Tuppiti^{22a,22b}, S. Turchikhin⁶⁸, D. Turgeman¹⁷⁵, I. Turk Cakir^{4b,as}, R. Turra^{94a,94b}, P. M. Tuts³⁸, G. Uccielli^{22a,22b}, I. Ueda¹⁵⁷, M. Ughetto^{148a,148b}, F. Ukegawa¹⁶⁴, G. Unal³², A. Undrus²⁷, G. Unel¹⁶⁶, F. C. Ungaro⁹¹, Y. Unno⁶⁹, C. Unverdorben¹⁰², J. Urban^{146b}, P. Urquijo⁹¹, P. Urrejola⁸⁶, G. Usai⁸, J. Usui⁶⁹, L. Vacavant⁸⁸, V. Vacek¹³⁰, B. Vachon⁹⁰, C. Valderanis¹⁰², E. Valdes Santurio^{148a,148b}, N. Valencic¹⁰⁹, S. Valentinetti^{22a,22b}, A. Valero¹⁷⁰, L. Valery¹³, S. Valkar¹³¹, J. A. Valls Ferrer¹⁷⁰, W. Van Den Wollenberg¹⁰⁹, P. C. Van Der Deijl¹⁰⁹, H. van der Graaf¹⁰⁹, N. van Eldik¹⁵⁴, P. van Gemmeren⁶, J. Van Nieuwkoop¹⁴⁴, I. van Vulpen¹⁰⁹, M. C. van Woerden¹⁰⁹, M. Vanadia^{134a,134b}, W. Vandelli³², R. Vanguri¹²⁴, A. Vaniachine¹⁶⁰, P. Vankov¹⁰⁹, G. Vardanyan¹⁸⁰, R. Vari^{134a}, E. W. Varnes⁷, T. Varol⁴³, D. Varouchas⁸³, A. Vartapetian⁸, K. E. Varvell¹⁵², J. G. Vasquez¹⁷⁹, G. A. Vasquez^{34b}, F. Vazeille³⁷, T. Vazquez Schroeder⁹⁰, J. Veatch⁵⁷, V. Veeraraghavan⁷, L. M. Veloce¹⁶¹, F. Veloso^{128a,128c}, S. Veneziano^{134a}, A. Ventura^{76a,76b}, M. Venturi¹⁷², N. Venturi¹⁶¹, A. Venturini²⁵, V. Vercesi^{123a}, M. Verducci^{134a,134b}, W. Verkerke¹⁰⁹, J. C. Vermeulen¹⁰⁹, A. Vest^{47,at}, M. C. Vetterli^{144,d}, O. Viazlo⁸⁴, I. Vichou^{169,*}, T. Vickey¹⁴¹, O. E. Vickey Boeriu¹⁴¹, G. H. A. Viehhauser¹²², S. Viel¹⁶, L. Vigani¹²², M. Villa^{22a,22b}, M. Villaplana Perez^{94a,94b}, E. Vilucchi⁵⁰, M. G. Vincker³¹, V. B. Vinogradov⁶⁸, C. Vittori^{22a,22b}, I. Vivarelli¹⁵¹, S. Vlachos¹⁰, M. Vlasak¹³⁰, M. Vogel¹⁷⁸, P. Vokac¹³⁰, G. Volpi^{126a,126b}, M. Volpi⁹¹, H. von der Schmitt¹⁰³, E. von Toerne²³, V. Vorobel¹³¹, K. Vorobev¹⁰⁰, M. Vos¹⁷⁰, R. Voss³², J. H. Vossebeld⁷⁷, N. Vranjes¹⁴, M. Vranjes Milosavljevic¹⁴, V. Vrba¹²⁹, M. Vreeswijk¹⁰⁹, R. Vuillermet³², I. Vukotic³³, P. Wagner²³, W. Wagner¹⁷⁸, H. Wahlberg⁷⁴, S. Wahrmond⁴⁷, J. Wakabayashi¹⁰⁵, J. Walder⁷⁵, R. Walker¹⁰², W. Walkowiak¹⁴³

V. Wallangen^{148a,148b}, C. Wang^{35b}, C. Wang^{36b,88}, F. Wang¹⁷⁶, H. Wang¹⁶, H. Wang⁴³, J. Wang⁴⁵, J. Wang¹⁵², K. Wang⁹⁰, R. Wang⁶, S. M. Wang¹⁵³, T. Wang³⁸, W. Wang^{36a}, C. Wanotayaroj¹¹⁸, A. Warburton⁹⁰, C. P. Ward³⁰, D. R. Wardrope⁸¹, A. Washbrook⁴⁹, P. M. Watkins¹⁹, A. T. Watson¹⁹, M. F. Watson¹⁹, G. Watts¹⁴⁰, S. Watts⁸⁷, B. M. Waugh⁸¹, S. Webb⁸⁶, M. S. Weber¹⁸, S. W. Weber¹⁷⁷, S. A. Weber³¹, J. S. Webster⁶, A. R. Weidberg¹²², B. Weinert⁶⁴, J. Weingarten⁵⁷, C. Weiser⁵¹, H. Weits¹⁰⁹, P. S. Wells³², T. Wenaus²⁷, T. Wengler³², S. Wenig³², N. Wermes²³, M. D. Werner⁶⁷, P. Werner³², M. Wessels^{60a}, J. Wetter¹⁶⁵, K. Whalen¹¹⁸, N. L. Whallon¹⁴⁰, A. M. Wharton⁷⁵, A. White⁸, M. J. White¹, R. White^{34b}, D. Whiteson¹⁶⁶, F. J. Wickens¹³³, W. Wiedenmann¹⁷⁶, M. Wielers¹³³, C. Wigglesworth³⁹, L. A. M. Wiik-Fuchs²³, A. Wildauer¹⁰³, F. Wilk⁸⁷, H. G. Wilkens³², H. H. Williams¹²⁴, S. Williams¹⁰⁹, C. Willis⁹³, S. Willocq⁸⁹, J. A. Wilson¹⁹, I. Wingerter-Seez⁵, F. Winklmeier¹¹⁸, O. J. Winston¹⁵¹, B. T. Winter²³, M. Wittgen¹⁴⁵, T. M. H. Wolf¹⁰⁹, R. Wolff⁸⁸, M. W. Wolter⁴², H. Wolters^{128a,128c}, S. D. Worm¹³³, B. K. Wosiek⁴², J. Wotschack³², M. J. Woudstra⁸⁷, K. W. Wozniak⁴², M. Wu⁵⁸, M. Wu³³, S. L. Wu¹⁷⁶, X. Wu⁵², Y. Wu⁹², T. R. Wyatt⁸⁷, B. M. Wynne⁴⁹, S. Xella³⁹, Z. Xi⁹², D. Xu^{35a}, L. Xu²⁷, B. Yabsley¹⁵², S. Yacoob^{147a}, D. Yamaguchi¹⁵⁹, Y. Yamaguchi¹²⁰, A. Yamamoto⁶⁹, S. Yamamoto¹⁵⁷, T. Yamanaka¹⁵⁷, K. Yamauchi¹⁰⁵, Y. Yamazaki⁷⁰, Z. Yan²⁴, H. Yang^{36c}, H. Yang¹⁷⁶, Y. Yang¹⁵³, Z. Yang¹⁵, W.-M. Yao¹⁶, Y. C. Yap⁸³, Y. Yasu⁶⁹, E. Yatsenko⁵, K. H. Yau Wong²³, J. Ye⁴³, S. Ye²⁷, I. Yeletsikh⁶⁸, E. Yildirim⁸⁶, K. Yorita¹⁷⁴, R. Yoshida⁶, K. Yoshihara¹²⁴, C. Young¹⁴⁵, C. J. S. Young³², S. Youssef²⁴, D. R. Yu¹⁶, J. Yu⁸, J. M. Yu⁹², J. Yu⁶⁷, L. Yuan⁷⁰, S. P. Y. Yuen²³, I. Yusuf^{30,au}, B. Zabinski⁴², G. Zacharis¹⁰, R. Zaidan⁶⁶, A. M. Zaitsev^{132,ae}, N. Zakharchuk⁴⁵, J. Zalieckas¹⁵, A. Zaman¹⁵⁰, S. Zambito⁵⁹, L. Zanello^{134a,134b}, D. Zanzi⁹¹, C. Zeitnitz¹⁷⁸, M. Zeman¹³⁰, A. Zemla^{41a}, J. C. Zeng¹⁶⁹, Q. Zeng¹⁴⁵, O. Zenin¹³², T. Ženiš^{146a}, D. Zerwas¹¹⁹, D. Zhang⁹², F. Zhang¹⁷⁶, G. Zhang^{36a,ao}, H. Zhang^{35b}, J. Zhang⁶, L. Zhang⁵¹, L. Zhang^{36a}, M. Zhang¹⁶⁹, R. Zhang²³, R. Zhang^{36a,av}, X. Zhang^{36b}, Z. Zhang¹¹⁹, X. Zhao⁴³, Y. Zhao^{36b,aw}, Z. Zhao^{36a}, A. Zhemchugov⁶⁸, J. Zhong¹²², B. Zhou⁹², C. Zhou¹⁷⁶, L. Zhou³⁸, L. Zhou⁴³, M. Zhou¹⁵⁰, N. Zhou^{35c}, C. G. Zhu^{36b}, H. Zhu^{35a}, J. Zhu⁹², Y. Zhu^{36a}, X. Zhuang^{35a}, K. Zhukov⁹⁸, A. Zibell¹⁷⁷, D. Zieminska⁶⁴, N. I. Zimine⁶⁸, C. Zimmermann⁸⁶, S. Zimmermann⁵¹, Z. Zinonos⁵⁷, M. Zinser⁸⁶, M. Ziolkowski¹⁴³, L. Živković¹⁴, G. Zobernig¹⁷⁶, A. Zoccoli^{22a,22b}, M. zur Nedden¹⁷, L. Zwalinski³²

¹ Department of Physics, University of Adelaide, Adelaide, Australia

² Physics Department, SUNY Albany, Albany, NY, USA

³ Department of Physics, University of Alberta, Edmonton, AB, Canada

⁴ (a) Department of Physics, Ankara University, Ankara, Turkey; (b) Istanbul Aydin University, Istanbul, Turkey; (c) Division of Physics, TOBB University of Economics and Technology, Ankara, Turkey

⁵ LAPP, CNRS/IN2P3 and Université Savoie Mont Blanc, Annecy-le-Vieux, France

⁶ High Energy Physics Division, Argonne National Laboratory, Argonne, IL, USA

⁷ Department of Physics, University of Arizona, Tucson, AZ, USA

⁸ Department of Physics, The University of Texas at Arlington, Arlington, TX, USA

⁹ Physics Department, National and Kapodistrian University of Athens, Athens, Greece

¹⁰ Physics Department, National Technical University of Athens, Zografou, Greece

¹¹ Department of Physics, The University of Texas at Austin, Austin, TX, USA

¹² Institute of Physics, Azerbaijan Academy of Sciences, Baku, Azerbaijan

¹³ Institut de Física d'Altes Energies (IFAE), The Barcelona Institute of Science and Technology, Barcelona, Spain

¹⁴ Institute of Physics, University of Belgrade, Belgrade, Serbia

¹⁵ Department for Physics and Technology, University of Bergen, Bergen, Norway

¹⁶ Physics Division, Lawrence Berkeley National Laboratory and University of California, Berkeley, CA, USA

¹⁷ Department of Physics, Humboldt University, Berlin, Germany

¹⁸ Albert Einstein Center for Fundamental Physics and Laboratory for High Energy Physics, University of Bern, Bern, Switzerland

¹⁹ School of Physics and Astronomy, University of Birmingham, Birmingham, UK

²⁰ (a) Department of Physics, Bogazici University, Istanbul, Turkey; (b) Department of Physics Engineering, Gaziantep University, Gaziantep, Turkey; (c) Faculty of Engineering and Natural Sciences, Istanbul Bilgi University, Istanbul, Turkey; (d) Faculty of Engineering and Natural Sciences, Bahcesehir University, Istanbul, Turkey

²¹ Centro de Investigaciones, Universidad Antonio Narino, Bogotá, Colombia

²² (a) INFN Sezione di Bologna, Bologna, Italy; (b) Dipartimento di Fisica e Astronomia, Università di Bologna, Bologna, Italy

²³ Physikalisches Institut, University of Bonn, Bonn, Germany

²⁴ Department of Physics, Boston University, Boston, MA, USA

- ²⁵ Department of Physics, Brandeis University, Waltham, MA, USA
- ²⁶ ^(a)Universidade Federal do Rio De Janeiro COPPE/EE/IF, Rio de Janeiro, Brazil; ^(b)Electrical Circuits Department, Federal University of Juiz de Fora (UFJF), Juiz de Fora, Brazil; ^(c)Federal University of Sao Joao del Rei (UFSJ), Sao Joao del Rei, Brazil; ^(d)Instituto de Fisica, Universidade de Sao Paulo, Sao Paulo, Brazil
- ²⁷ Physics Department, Brookhaven National Laboratory, Upton, NY, USA
- ²⁸ ^(a)Transilvania University of Brasov, Brasov, Romania; ^(b)Horia Hulubei National Institute of Physics and Nuclear Engineering, Bucharest, Romania; ^(c)Physics Department, National Institute for Research and Development of Isotopic and Molecular Technologies, Cluj-Napoca, Romania; ^(d)University Politehnica Bucharest, Bucharest, Romania; ^(e)West University in Timisoara, Timisoara, Romania
- ²⁹ Departamento de Física, Universidad de Buenos Aires, Buenos Aires, Argentina
- ³⁰ Cavendish Laboratory, University of Cambridge, Cambridge, UK
- ³¹ Department of Physics, Carleton University, Ottawa, ON, Canada
- ³² CERN, Geneva, Switzerland
- ³³ Enrico Fermi Institute, University of Chicago, Chicago, IL, USA
- ³⁴ ^(a)Departamento de Física, Pontificia Universidad Católica de Chile, Santiago, Chile; ^(b)Departamento de Física, Universidad Técnica Federico Santa María, Valparaiso, Chile
- ³⁵ ^(a)Institute of High Energy Physics, Chinese Academy of Sciences, Beijing, China; ^(b)Department of Physics, Nanjing University, Nanjing, Jiangsu, China; ^(c)Physics Department, Tsinghua University, Beijing 100084, China
- ³⁶ ^(a)Department of Modern Physics, University of Science and Technology of China, Hefei, Anhui, China; ^(b)School of Physics, Shandong University, Jinan, Shandong, China; ^(c)Department of Physics and Astronomy, Shanghai Key Laboratory for Particle Physics and Cosmology, Shanghai Jiao Tong University (also affiliated with PKU-CHEP), Shanghai, China
- ³⁷ Laboratoire de Physique Corpusculaire, Université Clermont Auvergne, Université Blaise Pascal, CNRS/IN2P3, Clermont-Ferrand, France
- ³⁸ Nevis Laboratory, Columbia University, Irvington, NY, USA
- ³⁹ Niels Bohr Institute, University of Copenhagen, Copenhagen, Denmark
- ⁴⁰ ^(a)INFN Gruppo Collegato di Cosenza, Laboratori Nazionali di Frascati, Frascati, Italy; ^(b)Dipartimento di Fisica, Università della Calabria, Rende, Italy
- ⁴¹ ^(a)Faculty of Physics and Applied Computer Science, AGH University of Science and Technology, Kraków, Poland; ^(b)Marian Smoluchowski Institute of Physics, Jagiellonian University, Kraków, Poland
- ⁴² Institute of Nuclear Physics Polish Academy of Sciences, Kraków, Poland
- ⁴³ Physics Department, Southern Methodist University, Dallas, TX, USA
- ⁴⁴ Physics Department, University of Texas at Dallas, Richardson, TX, USA
- ⁴⁵ DESY, Hamburg and Zeuthen, Germany
- ⁴⁶ Lehrstuhl für Experimentelle Physik IV, Technische Universität Dortmund, Dortmund, Germany
- ⁴⁷ Institut für Kern- und Teilchenphysik, Technische Universität Dresden, Dresden, Germany
- ⁴⁸ Department of Physics, Duke University, Durham, NC, USA
- ⁴⁹ SUPA-School of Physics and Astronomy, University of Edinburgh, Edinburgh, UK
- ⁵⁰ INFN Laboratori Nazionali di Frascati, Frascati, Italy
- ⁵¹ Fakultät für Mathematik und Physik, Albert-Ludwigs-Universität, Freiburg, Germany
- ⁵² Departement de Physique Nucleaire et Corpusculaire, Université de Genève, Geneva, Switzerland
- ⁵³ ^(a)INFN Sezione di Genova, Genoa, Italy; ^(b)Dipartimento di Fisica, Università di Genova, Genoa, Italy
- ⁵⁴ ^(a)E. Andronikashvili Institute of Physics, Iv. Javakhishvili Tbilisi State University, Tbilisi, Georgia; ^(b)High Energy Physics Institute, Tbilisi State University, Tbilisi, Georgia
- ⁵⁵ II Physikalisches Institut, Justus-Liebig-Universität Giessen, Giessen, Germany
- ⁵⁶ SUPA-School of Physics and Astronomy, University of Glasgow, Glasgow, UK
- ⁵⁷ II Physikalisches Institut, Georg-August-Universität, Göttingen, Germany
- ⁵⁸ Laboratoire de Physique Subatomique et de Cosmologie, Université Grenoble-Alpes, CNRS/IN2P3, Grenoble, France
- ⁵⁹ Laboratory for Particle Physics and Cosmology, Harvard University, Cambridge, MA, USA
- ⁶⁰ ^(a)Kirchhoff-Institut für Physik, Ruprecht-Karls-Universität Heidelberg, Heidelberg, Germany; ^(b)Physikalisches Institut, Ruprecht-Karls-Universität Heidelberg, Heidelberg, Germany; ^(c)ZITI Institut für technische Informatik, Ruprecht-Karls-Universität Heidelberg, Mannheim, Germany
- ⁶¹ Faculty of Applied Information Science, Hiroshima Institute of Technology, Hiroshima, Japan

- 62 (a)Department of Physics, The Chinese University of Hong Kong, Shatin, N.T., Hong Kong; (b)Department of Physics, The University of Hong Kong, Hong Kong, China; (c)Department of Physics and Institute for Advanced Study, The Hong Kong University of Science and Technology, Clear Water Bay, Kowloon, Hong Kong, China
- 63 Department of Physics, National Tsing Hua University, Taiwan, Taiwan
- 64 Department of Physics, Indiana University, Bloomington, IN, USA
- 65 Institut für Astro- und Teilchenphysik, Leopold-Franzens-Universität, Innsbruck, Austria
- 66 University of Iowa, Iowa City, IA, USA
- 67 Department of Physics and Astronomy, Iowa State University, Ames, IA, USA
- 68 Joint Institute for Nuclear Research, JINR Dubna, Dubna, Russia
- 69 KEK, High Energy Accelerator Research Organization, Tsukuba, Japan
- 70 Graduate School of Science, Kobe University, Kobe, Japan
- 71 Faculty of Science, Kyoto University, Kyoto, Japan
- 72 Kyoto University of Education, Kyoto, Japan
- 73 Department of Physics, Kyushu University, Fukuoka, Japan
- 74 Instituto de Física La Plata, Universidad Nacional de La Plata and CONICET, La Plata, Argentina
- 75 Physics Department, Lancaster University, Lancaster, UK
- 76 (a)INFN Sezione di Lecce, Lecce, Italy; (b)Dipartimento di Matematica e Fisica, Università del Salento, Lecce, Italy
- 77 Oliver Lodge Laboratory, University of Liverpool, Liverpool, UK
- 78 Department of Experimental Particle Physics, Jožef Stefan Institute and Department of Physics, University of Ljubljana, Ljubljana, Slovenia
- 79 School of Physics and Astronomy, Queen Mary University of London, London, UK
- 80 Department of Physics, Royal Holloway University of London, Surrey, UK
- 81 Department of Physics and Astronomy, University College London, London, UK
- 82 Louisiana Tech University, Ruston, LA, USA
- 83 Laboratoire de Physique Nucléaire et de Hautes Energies, UPMC and Université Paris-Diderot and CNRS/IN2P3, Paris, France
- 84 Fysiska institutionen, Lunds universitet, Lund, Sweden
- 85 Departamento de Física Teórica C-15, Universidad Autónoma de Madrid, Madrid, Spain
- 86 Institut für Physik, Universität Mainz, Mainz, Germany
- 87 School of Physics and Astronomy, University of Manchester, Manchester, UK
- 88 CPPM, Aix-Marseille Université and CNRS/IN2P3, Marseille, France
- 89 Department of Physics, University of Massachusetts, Amherst, MA, USA
- 90 Department of Physics, McGill University, Montreal, QC, Canada
- 91 School of Physics, University of Melbourne, Victoria, Australia
- 92 Department of Physics, The University of Michigan, Ann Arbor, MI, USA
- 93 Department of Physics and Astronomy, Michigan State University, East Lansing, MI, USA
- 94 (a)INFN Sezione di Milano, Milan, Italy; (b)Dipartimento di Fisica, Università di Milano, Milan, Italy
- 95 B.I. Stepanov Institute of Physics, National Academy of Sciences of Belarus, Minsk, Republic of Belarus
- 96 Research Institute for Nuclear Problems of Byelorussian State University, Minsk, Republic of Belarus
- 97 Group of Particle Physics, University of Montreal, Montreal, QC, Canada
- 98 P.N. Lebedev Physical Institute of the Russian Academy of Sciences, Moscow, Russia
- 99 Institute for Theoretical and Experimental Physics (ITEP), Moscow, Russia
- 100 National Research Nuclear University MEPhI, Moscow, Russia
- 101 D.V. Skobeltsyn Institute of Nuclear Physics, M.V. Lomonosov Moscow State University, Moscow, Russia
- 102 Fakultät für Physik, Ludwig-Maximilians-Universität München, Munich, Germany
- 103 Max-Planck-Institut für Physik (Werner-Heisenberg-Institut), Munich, Germany
- 104 Nagasaki Institute of Applied Science, Nagasaki, Japan
- 105 Graduate School of Science and Kobayashi-Maskawa Institute, Nagoya University, Nagoya, Japan
- 106 (a)INFN Sezione di Napoli, Naples, Italy; (b)Dipartimento di Fisica, Università di Napoli, Naples, Italy
- 107 Department of Physics and Astronomy, University of New Mexico, Albuquerque, NM, USA
- 108 Institute for Mathematics, Astrophysics and Particle Physics, Radboud University Nijmegen/Nikhef, Nijmegen, The Netherlands
- 109 Nikhef National Institute for Subatomic Physics and University of Amsterdam, Amsterdam, The Netherlands

- 110 Department of Physics, Northern Illinois University, DeKalb, IL, USA
- 111 Budker Institute of Nuclear Physics, SB RAS, Novosibirsk, Russia
- 112 Department of Physics, New York University, New York, NY, USA
- 113 Ohio State University, Columbus, OH, USA
- 114 Faculty of Science, Okayama University, Okayama, Japan
- 115 Homer L. Dodge Department of Physics and Astronomy, University of Oklahoma, Norman, OK, USA
- 116 Department of Physics, Oklahoma State University, Stillwater, OK, USA
- 117 Palacký University, RCPTM, Olomouc, Czech Republic
- 118 Center for High Energy Physics, University of Oregon, Eugene, OR, USA
- 119 LAL, Univ. Paris-Sud, CNRS/IN2P3, Université Paris-Saclay, Orsay, France
- 120 Graduate School of Science, Osaka University, Osaka, Japan
- 121 Department of Physics, University of Oslo, Oslo, Norway
- 122 Department of Physics, Oxford University, Oxford, UK
- 123 ^(a)INFN Sezione di Pavia, Pavia, Italy; ^(b)Dipartimento di Fisica, Università di Pavia, Pavia, Italy
- 124 Department of Physics, University of Pennsylvania, Philadelphia, PA, USA
- 125 National Research Centre “Kurchatov Institute” B.P. Konstantinov Petersburg Nuclear Physics Institute, St. Petersburg, Russia
- 126 ^(a)INFN Sezione di Pisa, Pisa, Italy; ^(b)Dipartimento di Fisica E. Fermi, Università di Pisa, Pisa, Italy
- 127 Department of Physics and Astronomy, University of Pittsburgh, Pittsburgh, PA, USA
- 128 ^(a)Laboratório de Instrumentação e Física Experimental de Partículas-LIP, Lisbon, Portugal; ^(b)Faculdade de Ciências, Universidade de Lisboa, Lisbon, Portugal; ^(c)Department of Physics, University of Coimbra, Coimbra, Portugal; ^(d)Centro de Física Nuclear da Universidade de Lisboa, Lisbon, Portugal; ^(e)Departamento de Física, Universidade do Minho, Braga, Portugal; ^(f)Departamento de Física Teórica y del Cosmos and CAFPE, Universidad de Granada, Granada, Spain; ^(g)Dep Física and CEFITEC of Faculdade de Ciências e Tecnologia, Universidade Nova de Lisboa, Caparica, Portugal
- 129 Institute of Physics, Academy of Sciences of the Czech Republic, Prague, Czech Republic
- 130 Czech Technical University in Prague, Prague, Czech Republic
- 131 Faculty of Mathematics and Physics, Charles University in Prague, Prague, Czech Republic
- 132 State Research Center Institute for High Energy Physics (Protvino), NRC KI, Protvino, Russia
- 133 Particle Physics Department, Rutherford Appleton Laboratory, Didcot, UK
- 134 ^(a)INFN Sezione di Roma, Rome, Italy; ^(b)Dipartimento di Fisica, Sapienza Università di Roma, Rome, Italy
- 135 ^(a)INFN Sezione di Roma Tor Vergata, Rome, Italy; ^(b)Dipartimento di Fisica, Università di Roma Tor Vergata, Rome, Italy
- 136 ^(a)INFN Sezione di Roma Tre, Rome, Italy; ^(b)Dipartimento di Matematica e Fisica, Università Roma Tre, Rome, Italy
- 137 ^(a)Faculté des Sciences Ain Chock, Réseau Universitaire de Physique des Hautes Energies-Université Hassan II, Casablanca, Morocco; ^(b)Centre National de l’Energie des Sciences Techniques Nucleaires, Rabat, Morocco; ^(c)Faculté des Sciences Semlalia, Université Cadi Ayyad, LPHEA-Marrakech, Marrakech, Morocco; ^(d)Faculté des Sciences, Université Mohamed Premier and LPTPM, Oujda, Morocco; ^(e)Faculté des Sciences, Université Mohammed V, Rabat, Morocco
- 138 DSM/IRFU (Institut de Recherches sur les Lois Fondamentales de l’Univers), CEA Saclay (Commissariat à l’Energie Atomique et aux Energies Alternatives), Gif-sur-Yvette, France
- 139 Santa Cruz Institute for Particle Physics, University of California Santa Cruz, Santa Cruz, CA, USA
- 140 Department of Physics, University of Washington, Seattle, WA, USA
- 141 Department of Physics and Astronomy, University of Sheffield, Sheffield, UK
- 142 Department of Physics, Shinshu University, Nagano, Japan
- 143 Fachbereich Physik, Universität Siegen, Siegen, Germany
- 144 Department of Physics, Simon Fraser University, Burnaby, BC, Canada
- 145 SLAC National Accelerator Laboratory, Stanford, CA, USA
- 146 ^(a)Faculty of Mathematics, Physics and Informatics, Comenius University, Bratislava, Slovak Republic; ^(b)Department of Subnuclear Physics, Institute of Experimental Physics of the Slovak Academy of Sciences, Kosice, Slovak Republic
- 147 ^(a)Department of Physics, University of Cape Town, Cape Town, South Africa; ^(b)Department of Physics, University of Johannesburg, Johannesburg, South Africa; ^(c)School of Physics, University of the Witwatersrand, Johannesburg, South Africa

- 148 ^(a)Department of Physics, Stockholm University, Stockholm, Sweden; ^(b)The Oskar Klein Centre, Stockholm, Sweden
- 149 Physics Department, Royal Institute of Technology, Stockholm, Sweden
- 150 Departments of Physics and Astronomy and Chemistry, Stony Brook University, Stony Brook, NY, USA
- 151 Department of Physics and Astronomy, University of Sussex, Brighton, UK
- 152 School of Physics, University of Sydney, Sydney, Australia
- 153 Institute of Physics, Academia Sinica, Taipei, Taiwan
- 154 Department of Physics, Technion: Israel Institute of Technology, Haifa, Israel
- 155 Raymond and Beverly Sackler School of Physics and Astronomy, Tel Aviv University, Tel Aviv, Israel
- 156 Department of Physics, Aristotle University of Thessaloniki, Thessaloníki, Greece
- 157 International Center for Elementary Particle Physics and Department of Physics, The University of Tokyo, Tokyo, Japan
- 158 Graduate School of Science and Technology, Tokyo Metropolitan University, Tokyo, Japan
- 159 Department of Physics, Tokyo Institute of Technology, Tokyo, Japan
- 160 Tomsk State University, Tomsk, Russia
- 161 Department of Physics, University of Toronto, Toronto, ON, Canada
- 162 ^(a)INFN-TIFPA, Trento, Italy; ^(b)University of Trento, Trento, Italy
- 163 ^(a)TRIUMF, Vancouver, BC, Canada; ^(b)Department of Physics and Astronomy, York University, Toronto, ON, Canada
- 164 Faculty of Pure and Applied Sciences, and Center for Integrated Research in Fundamental Science and Engineering, University of Tsukuba, Tsukuba, Japan
- 165 Department of Physics and Astronomy, Tufts University, Medford, MA, USA
- 166 Department of Physics and Astronomy, University of California Irvine, Irvine, CA, USA
- 167 ^(a)INFN Gruppo Collegato di Udine, Sezione di Trieste, Udine, Italy; ^(b)ICTP, Trieste, Italy; ^(c)Dipartimento di Chimica, Fisica e Ambiente, Università di Udine, Udine, Italy
- 168 Department of Physics and Astronomy, University of Uppsala, Uppsala, Sweden
- 169 Department of Physics, University of Illinois, Urbana, IL, USA
- 170 Instituto de Física Corpuscular (IFIC) and Departamento de Física Atomica, Molecular y Nuclear and Departamento de Ingeniería Electrónica and Instituto de Microelectrónica de Barcelona (IMB-CNM), University of Valencia and CSIC, Valencia, Spain
- 171 Department of Physics, University of British Columbia, Vancouver, BC, Canada
- 172 Department of Physics and Astronomy, University of Victoria, Victoria, BC, Canada
- 173 Department of Physics, University of Warwick, Coventry, UK
- 174 Waseda University, Tokyo, Japan
- 175 Department of Particle Physics, The Weizmann Institute of Science, Rehovot, Israel
- 176 Department of Physics, University of Wisconsin, Madison, WI, USA
- 177 Fakultät für Physik und Astronomie, Julius-Maximilians-Universität, Würzburg, Germany
- 178 Fakultät für Mathematik und Naturwissenschaften, Fachgruppe Physik, Bergische Universität Wuppertal, Wuppertal, Germany
- 179 Department of Physics, Yale University, New Haven, CT, USA
- 180 Yerevan Physics Institute, Yerevan, Armenia
- 181 Centre de Calcul de l'Institut National de Physique Nucléaire et de Physique des Particules (IN2P3), Villeurbanne, France
- ^a Also at Department of Physics, King's College London, London, UK
- ^b Also at Institute of Physics, Azerbaijan Academy of Sciences, Baku, Azerbaijan
- ^c Also at Novosibirsk State University, Novosibirsk, Russia
- ^d Also at TRIUMF, Vancouver, BC, Canada
- ^e Also at Department of Physics and Astronomy, University of Louisville, Louisville, KY, USA
- ^f Also at Physics Department, An-Najah National University, Nablus, Palestine
- ^g Also at Department of Physics, California State University, Fresno, CA, USA
- ^h Also at Department of Physics, University of Fribourg, Fribourg, Switzerland
- ⁱ Also at Departament de Física de la Universitat Autònoma de Barcelona, Barcelona, Spain
- ^j Also at Departamento de Física e Astronomia, Faculdade de Ciências, Universidade do Porto, Portugal
- ^k Also at Tomsk State University, Tomsk, Russia
- ^l Also at Università di Napoli Parthenope, Naples, Italy
- ^m Also at Institute of Particle Physics (IPP), Canada

- ⁿ Also at Horia Hulubei National Institute of Physics and Nuclear Engineering, Bucharest, Romania
- ^o Also at Department of Physics, St. Petersburg State Polytechnical University, St. Petersburg, Russia
- ^p Also at Department of Physics, The University of Michigan, Ann Arbor, MI, USA
- ^q Also at Centre for High Performance Computing, CSIR Campus, Rosebank, Cape Town, South Africa
- ^r Also at Louisiana Tech University, Ruston, LA, USA
- ^s Also at Institutio Catalana de Recerca i Estudis Avancats, ICREA, Barcelona, Spain
- ^t Also at Graduate School of Science, Osaka University, Osaka, Japan
- ^u Also at Institute for Mathematics, Astrophysics and Particle Physics, Radboud University Nijmegen/Nikhef, Nijmegen, Netherlands
- ^v Also at Department of Physics, The University of Texas at Austin, Austin, TX, USA
- ^w Also at Institute of Theoretical Physics, Ilia State University, Tbilisi, Georgia
- ^x Also at CERN, Geneva, Switzerland
- ^y Also at Georgian Technical University (GTU), Tbilisi, Georgia
- ^z Also at Ochadai Academic Production, Ochanomizu University, Tokyo, Japan
- ^{aa} Also at Manhattan College, New York, NY, USA
- ^{ab} Also at Academia Sinica Grid Computing, Institute of Physics, Academia Sinica, Taipei, Taiwan
- ^{ac} Also at School of Physics, Shandong University, Shandong, China
- ^{ad} Also at Department of Physics, California State University, Sacramento, CA, USA
- ^{ae} Also at Moscow Institute of Physics and Technology State University, Dolgoprudny, Russia
- ^{af} Also at Departement de Physique Nucleaire et Corpusculaire, Université de Genève, Geneva, Switzerland
- ^{ag} Also at Eotvos Lorand University, Budapest, Hungary
- ^{ah} Also at Departments of Physics and Astronomy and Chemistry, Stony Brook University, Stony Brook, NY, USA
- ^{ai} Also at International School for Advanced Studies (SISSA), Trieste, Italy
- ^{aj} Also at Department of Physics and Astronomy, University of South Carolina, Columbia, SC, USA
- ^{ak} Also at Institut de Física d'Altes Energies (IFAE), The Barcelona Institute of Science and Technology, Barcelona, Spain
- ^{al} Also at School of Physics, Sun Yat-sen University, Guangzhou, China
- ^{am} Also at Institute for Nuclear Research and Nuclear Energy (INRNE) of the Bulgarian Academy of Sciences, Sofia, Bulgaria
- ^{an} Also at Faculty of Physics, M.V.Lomonosov Moscow State University, Moscow, Russia
- ^{ao} Also at Institute of Physics, Academia Sinica, Taipei, Taiwan
- ^{ap} Also at National Research Nuclear University MEPhI, Moscow, Russia
- ^{aq} Also at Department of Physics, Stanford University, Stanford, CA, USA
- ^{ar} Also at Institute for Particle and Nuclear Physics, Wigner Research Centre for Physics, Budapest, Hungary
- ^{as} Also at Giresun University, Faculty of Engineering, Turkey
- ^{at} Also at Flensburg University of Applied Sciences, Flensburg, Germany
- ^{au} Also at University of Malaya, Department of Physics, Kuala Lumpur, Malaysia
- ^{av} Also at CPPM, Aix-Marseille Université and CNRS/IN2P3, Marseille, France
- ^{aw} Also at LAL, Univ. Paris-Sud, CNRS/IN2P3, Université Paris-Saclay, Orsay, France
- *Deceased

SEARCH FOR A CORRELATION BETWEEN ANTARES NEUTRINOS AND PIERRE AUGER OBSERVATORY UHECRs ARRIVAL DIRECTIONS

S. ADRIÁN-MARTÍNEZ¹, I. AL SAMARAI², A. ALBERT³, M. ANDRÉ⁴, M. ANGHINOLFI⁵, G. ANTON⁶, S. ANVAR⁷, M. ARDID¹, T. ASTRAATMADJA^{8,38}, J.-J. AUBERT², B. BARET⁹, S. BASA¹⁰, L. J. BEEMSTER⁸, V. BERTIN², S. BIAGI^{11,12}, C. BIGONGIARI¹³, C. BOGAZZI⁸, M. BOU-CABO¹, B. BOUHOUB⁹, M. C. BOUWHUIS⁸, J. BRUNNER^{2,39}, J. BUSTO², F. CAMARENA¹, A. CAPONE^{14,15}, C. CÂRLOGANU¹⁶, G. CARMINATI^{11,12,40}, J. CARR², S. CECCHINI¹¹, Z. CHARIF², PH. CHARVIS¹⁷, T. CHIARUSI¹¹, M. CIRCELLA¹⁸, R. CONIGLIONE¹⁹, L. CORE², H. COSTANTINI², P. COYLE², A. CREUSOT⁹, C. CURTIL², G. DE BONIS^{14,15}, M. P. DECOWSKI⁸, I. DEKEYSER²⁰, A. DESCHAMPS¹⁷, C. DISTEFANO¹⁹, C. DONZAUD^{9,21}, D. DORNIC², Q. DOROSTI²², D. DROUHIN³, T. EBERL⁶, U. EMANUELE¹³, A. ENZENHÖFER⁶, J.-P. ERNENWEIN², S. ESCOFFIER², K. FEHN⁶, P. FERMANI^{14,15}, M. FERRI¹, S. FERRY²³, V. FLAMINIO^{24,25}, F. FOLGER⁶, U. FRITSCH⁶, J.-L. FUDA²⁰, S. GALATÀ², P. GAY¹⁶, K. GEYER⁶, G. GIACOMELLI^{11,12}, V. GIORDANO¹⁹, J. P. GÓMEZ-GONZÁLEZ¹³, K. GRAF⁶, G. GUILLARD¹⁶, G. HALLADJIAN², G. HALLEWELL², H. VAN HAREN²⁶, J. HARTMAN⁸, A. J. HEIJBOER⁸, Y. HELLO¹⁷, J. J. HERNÁNDEZ-REY¹³, B. HEROLD⁶, J. HÖBL⁶, C. C. HSU⁸, M. DE JONG^{8,38}, M. KADLER²⁷, O. KALEKIN⁶, A. KAPPES⁶, U. KATZ⁶, O. KAVATSYUK²², P. KOOLIJMAN^{8,28,29}, C. KOPPER^{6,8}, A. KOUCHNER⁹, I. KREYKENBOHM²⁷, V. KULIKOVSKIY^{5,30}, R. LAHMANN⁶, G. LAMBARD¹³, G. LAROSA¹, D. LATTUADA¹⁹, D. LEFÈVRE²⁰, G. LIM^{8,29}, D. LO PRESTI^{31,32}, H. LOEHNER²², S. LOUCATOS²³, F. LOUIS⁷, S. MANGANO¹³, M. MARCELIN¹⁰, A. MARGIOTTA^{11,12}, J. A. MARTÍNEZ-MORA¹, A. MELI⁶, T. MONTARULI^{18,33}, N. MORGANTI²⁴, L. MOSCOSO^{9,23,41}, H. MOTZ⁶, M. NEFF⁶, E. NEZRI¹⁰, D. PALIOSELITIS⁸, G. E. PÁVĀLAS³⁴, K. PAYET²³, P. PAYRE^{2,41}, J. PETROVIC^{8,42}, N. PICOT-CLEMENTE², V. POPA³⁴, T. PRADIER³⁵, E. PRESANI⁸, C. RACCA³, C. REED⁸, G. RICCOBENE¹⁹, C. RICHARDT⁶, R. RICHTER⁶, C. RIVIÈRE², A. ROBERT²⁰, K. ROENSCH⁶, A. ROSTOVTSV³⁶, J. RUIZ-RIVAS¹³, M. RUJOIU³⁴, G. V. RUSSO^{31,32}, F. SALESA¹³, D. F. E. SAMTLEBEN⁸, A. SÁNCHEZ-LOSA¹³, P. SAPIENZA¹⁹, F. SCHÖCK⁶, J.-P. SCHULLER²³, F. SCHÜSSLER²³, T. SEITZ⁶, R. SHANIDZE⁶, F. SIMEONE^{14,15}, A. SPIES⁶, M. SPURIO^{11,12}, J. J. M. STEIJGER⁸, TH. STOLARCZYK²³, M. TAIUTI^{5,37}, C. TAMBURINI²⁰, S. TOSCANO¹³, B. VALLAGE²³, C. VALLÉE², V. VAN ELEWYCK⁹, G. VANNONI²³, M. VECCHI², P. VERNIN²³, E. VISSER⁸, S. WAGNER⁶, G. WIJNKER⁸, J. WILMS²⁷, E. DE WOLF^{8,29}, H. YEPES¹³, D. ZABOROV³⁶, J. D. ZORNOZA¹³, AND J. ZÚÑIGA¹³

¹ Institut d'Investigació per a la Gestió Integrada de les Zones Costaneres (IGIC), Universitat Politècnica de València, C/ Paranimf 1, E-46730 Gandia, Spain

² CPPM, Aix-Marseille Université, CNRS/IN2P3, F-13288 Marseille, France

³ GRPHE-Institut universitaire de technologie de Colmar, 34 rue du Grillenbreit BP 50568-68008 Colmar, France

⁴ Laboratory of Applied Bioacoustics, Technical University of Catalonia, Rambla Exposició, E-08800 Vilanova i la Geltrú, Barcelona, Spain

⁵ INFN-Sezione di Genova, Via Dodecaneso 33, I-16146 Genova, Italy

⁶ Friedrich-Alexander-Universität Erlangen-Nürnberg, Erlangen Centre for Astroparticle Physics, Erwin-Rommel-Str. 1, D-91058 Erlangen, Germany

⁷ Direction des Sciences de la Matière, Institut de recherche sur les lois fondamentales de l'Univers, Service d'Electronique des

Détecteurs et d'Informatique, CEA Saclay, F-91191 Gif-sur-Yvette Cedex, France

⁸ Nikhef, Science Park, Amsterdam, The Netherlands

⁹ APC-Laboratoire AstroParticule et Cosmologie, UMR 7164 (CNRS, Université Paris 7 Diderot, CEA, Observatoire de Paris) 10, rue Alice Domon et Léonie Duquet, F-75205 Paris Cedex 13, France

¹⁰ LAM-Laboratoire d'Astrophysique de Marseille, Pôle de l'Étoile Site de Château-Gombert, rue Frédéric Joliot-Curie 38, F-13388 Marseille Cedex 13, France

¹¹ INFN-Sezione di Bologna, Viale Berti-Pichat 6/2, I-40127 Bologna, Italy

¹² Dipartimento di Fisica dell'Università, Viale Berti Pichat 6/2, I-40127 Bologna, Italy

¹³ IFIC-Instituto de Física Corpuscular, Edificios Investigación de Paterna CSIC, Universitat de València, Apdo. de Correos 22085, E-46071 Valencia, Spain

¹⁴ INFN-Sezione di Roma, P.le Aldo Moro 2, I-00185 Roma, Italy

¹⁵ Dipartimento di Fisica dell'Università La Sapienza, P.le Aldo Moro 2, I-00185 Roma, Italy

¹⁶ Clermont Université, Université Blaise Pascal, CNRS/IN2P3, Laboratoire de Physique Corpusculaire, BP 10448, F-63000 Clermont-Ferrand, France

¹⁷ Géoazur-Université de Nice Sophia-Antipolis, CNRS/INSU, IRD, Observatoire de la Côte d'Azur and

Université Pierre et Marie Curie, BP 48, F-06235 Villefranche-sur-mer, France

¹⁸ INFN-Sezione di Bari, Via E. Orabona 4, I-70126 Bari, Italy

¹⁹ INFN-Laboratori Nazionali del Sud (LNS), Via S. Sofia 62, I-95123 Catania, Italy

²⁰ COM-Centre d'Océanologie de Marseille, CNRS/INSU et Université de la Méditerranée, 163 Avenue de Luminy, Case 901, F-13288 Marseille Cedex 9, France

²¹ Univ Paris-Sud, F-91405 Orsay Cedex, France

²² Kernfysisch Versneller Instituut (KVI), University of Groningen, Zernikelaan 25, 9747 AA Groningen, The Netherlands

²³ Direction des Sciences de la Matière-Institut de recherche sur les lois fondamentales de l'Univers, Service de Physique des Particules, CEA Saclay, F-91191 Gif-sur-Yvette Cedex, France

²⁴ INFN-Sezione di Pisa, Largo B. Pontecorvo 3, I-56127 Pisa, Italy

²⁵ Dipartimento di Fisica dell'Università, Largo B. Pontecorvo 3, I-56127 Pisa, Italy

²⁶ Royal Netherlands Institute for Sea Research (NIOZ), Landsdiep 4, 1797 SZ 't Horntje (Texel), The Netherlands

²⁷ Dr. Remeis-Sternwarte and ECAP, Universität Erlangen-Nürnberg, Sternwartstr. 7, D-96049 Bamberg, Germany

²⁸ Universiteit Utrecht, Faculteit Betawetenschappen, Princetonplein 5, 3584 CC Utrecht, The Netherlands

²⁹ Universiteit van Amsterdam, Instituut voor Hoge-Energie Fysika, Science Park 105, 1098 XG Amsterdam, The Netherlands

³⁰ Skobeltsyn Institute of Nuclear Physics, Moscow State University, Leninskie gory, 119991 Moscow, Russia

³¹ INFN-Sezione di Catania, Viale Andrea Doria 6, I-95125 Catania, Italy

³² Dipartimento di Fisica ed Astronomia dell'Università, Viale Andrea Doria 6, I-95125 Catania, Italy

³³ DPNC, Université de Genève, 1211 Geneva, Switzerland

³⁴ Institute for Space Sciences, R-77125 Bucharest, Măgurele, Romania

³⁵ IPHC-Institut Pluridisciplinaire Hubert Curien, Université de Strasbourg et CNRS/IN2P3 23 rue du Loess, BP 28, F-67037 Strasbourg Cedex 2, France

³⁶ ITEP-Institute for Theoretical and Experimental Physics, B. Cheremushkinskaya 25, 117218 Moscow, Russia

³⁷ Dipartimento di Fisica dell'Università, Via Dodecaneso 33, I-16146 Genova, Italy

Received 2012 May 23; accepted 2013 June 20; published 2013 August 12

ABSTRACT

A multimessenger analysis optimized for a correlation of arrival directions of ultra-high energy cosmic rays (UHECRs) and neutrinos is presented and applied to 2190 neutrino candidate events detected in 2007–2008 by the ANTARES telescope and 69 UHECRs observed by the Pierre Auger Observatory between 2004 January 1 and 2009 December 31. No significant correlation is observed. Assuming an equal neutrino flux (E^{-2} energy spectrum) from all UHECR directions, a 90% CL upper limit on the neutrino flux of 5.0×10^{-8} GeV cm $^{-2}$ s $^{-1}$ per source is derived.

Key words: astroparticle physics – cosmic rays – neutrinos

Online-only material: color figures

1. INTRODUCTION

The astrophysical sources of ultra-high energy cosmic rays (UHECRs) and neutrinos remain unknown. Astrophysical sources expected to produce comparable fluxes of cosmic rays and neutrinos are, for example, the jets of gamma-ray bursts (Waxman 1995; Vietri 1995; Waxman & Bahcall 1997; Murase et al. 2006) or active galactic nuclei (AGNs; Biermann & Strittmatter 1987; Rachen & Biermann 1993; Nellen et al. 1993; Mannheim 1995; Rachen 2008).

The search for UHECR sources is complicated by their deflection in magnetic fields inside and outside of our Galaxy. While the existence of a cut-off in the energy spectrum of UHECRs, first observed by the High Resolution Fly’s Eye cosmic-ray detector (HiRes) experiment (Abbasi et al. 2008a, 2009b), has now been confirmed by the data of the Pierre Auger Observatory (Abraham et al. 2008a, 2010), the composition of cosmic rays above a few 10^{18} eV, crucial for the estimation of expected magnetic deflection magnitudes, remains uncertain. Although data from the Pierre Auger Observatory seem to indicate a transition from a light to a heavy composition above 40 EeV, this trend is still subject to large uncertainties, in particular related to the lack of accurate modeling of hadronic interactions in the relevant energy domain.

Due to their interactions with photons of the cosmic microwave background via the GZK mechanism (Greisen 1966; Zatsepin & Kuzmin 1966), UHECR propagation distances are limited, for example, the proton energy loss distance above 10^{20} eV is about 100 Mpc. This means that only nearby astrophysical sources, lying within the GZK sphere could possibly be identified as UHECR acceleration sites. This has been extensively discussed in the context of model-dependent theoretical upper bounds on neutrino fluxes by Waxman & Bahcall (1999), Rachen et al. (2000), Mannheim et al. (2001), and Bahcall & Waxman (2001).

A multimessenger approach to the problem of the identification of UHECR sources is based on the detection of secondary fluxes of gamma-rays and neutrinos associated with the decay of pions resulting from the interaction of UHECRs with matter or photon fields in the vicinity of the cosmic accelerators (Waxman & Bahcall 1999; Rachen et al. 2000; Mannheim et al. 2001; Bahcall & Waxman 2001; Becker 2008; Becker & Biermann 2009). Although gamma-rays have been linked to astrophysical sources by recent observations (HESS, MAGIC, VERITAS, *Fermi*), an unambiguous identification of these

sources as sites of hadronic acceleration requires the detection of the associated neutrino flux. Neutrinos, being neutral and weakly interacting particles, are neither deflected nor attenuated during their propagation from their sources to the Earth. Their small cross-section for interaction with matter, however, makes their detection challenging and requires the construction of very large telescopes. Indeed, the currently operating neutrino telescopes, ANTARES, IceCube and BAIKAL, have not yet observed any statistically significant cosmic neutrino source (Adrián-Martínez et al. 2011, 2012; Abbasi et al. 2011; Avrorin et al. 2009).

In this paper, the first UHECR-neutrino multimessenger study is presented. A source stacking method optimized for a correlation of arrival directions of UHECRs and neutrinos has been developed and applied on the neutrino candidate events detected by the ANTARES telescope and the UHECR events observed by the Pierre Auger Observatory. If such a correlation were observed, it would indicate regions of the sky where the sources of UHECR and neutrinos could plausibly lie, as well as shed light both on the UHECR composition and on the intensity of magnetic fields in and outside of our Galaxy. An observed correlation would also exclude the possibility that the dominant sources of UHECRs are single-shot transient sources, since the time delay between neutrinos and protons coming from such a source is expected to be orders of magnitude larger than the observation times of the ANTARES telescope and the Pierre Auger Observatory.

It should be noted that not all astrophysical sources where protons are accelerated are necessarily sources of neutrinos. Astrophysical sources already mentioned, which are expected to produce comparable fluxes of neutrinos and cosmic rays, have proton interaction opacity $\tau = D_s \sigma \rho \gtrsim 1$ (σ is the cross-section for proton–photon and proton–proton interactions, ρ is the number density of photons and D_s is the scale dimension of the source).

Astrophysical sources with large proton interaction mean free path (corresponding to $\tau \ll 1$) may just accelerate and eject UHECR without producing significant neutrino fluxes. Examples for this class could be large-scale cosmic structure shocks (Kang & Jones 2005; Ma et al. 2011), accretion shocks around clusters of galaxies (Kang et al. 1996, 1997), or radio galaxy lobes and hot spots (Rachen & Biermann 1993). In this case, some of the arrival directions of the observed UHECRs would be correlated with the arrival directions of neutrinos, and some would not.

Sources with small proton interaction mean free path ($\tau \gg 1$) would absorb all accelerated cosmic rays in interactions and only neutrinos would be emitted. A model presented by Stecker et al. (1991) falls into this class. In this case a cosmic neutrino flux (likely isotropic) would be expected.

³⁸ Also at University of Leiden, The Netherlands.

³⁹ On leave at DESY, Platanenallee 6, D-15738 Zeuthen, Germany.

⁴⁰ Now at University of California, Irvine, CA 92697, USA.

⁴¹ Deceased.

⁴² Corresponding author.

For this analysis, the scenario with $\tau \gtrsim 1$ is considered, i.e., it is assumed that all observed cosmic ray sources also emit neutrinos. It is important to mention that in this scenario, the cross section for nuclear disintegration is much larger than the pion production cross section relevant for neutrino production. This means that nuclei are expected to be fully disintegrated before they leave the source, and that ejected cosmic rays are mostly protons.

This paper is organized as follows. The source stacking method is described in Section 2. A discussion about the deflection of UHECRs in magnetic fields is presented in Section 3. The data samples are presented in Section 4 and the background and signal simulations are explained in Section 5. The angular search bin optimization is discussed in Section 6 and the discovery potential in Section 7. The results are given in Section 8.

2. SOURCE STACKING METHOD

Source stacking is a method of noise reduction. The signal adds up linearly with the number of like sources, but the noise goes up roughly with the square root of the sum of squares of background counts around all sources. In other words, the signal-to-noise ratio increases proportionally to the square root of the number of sources. Stacking multiple sources in neutrino astronomy has been an effective way to enhance discovery potential and further constrain astrophysical models (Achterberg et al. 2006; Abbasi et al. 2009a, 2011).

In this analysis, all neutrino candidates observed by the ANTARES telescope in 2007 and 2008, scrambled in right ascension (thus blinding the data set), are considered to be the background. Signal events positioned in the directions of UHECRs observed by the Auger Observatory are added on top of this background in Monte Carlo (MC) simulations. From those simulations, signal counts needed to claim discovery are obtained.

A previously published analysis of the ANTARES telescope observations (Adrián-Martínez et al. 2011, 2012) showed that neither the whole-sky search for hot spots in the neutrino sky nor the search at predefined and astrophysically motivated source positions have led to the discovery of a statistically significant neutrino signal. This, however, does not exclude the possibility that the superposition of weak signals from generically equal sources, each contributing below the individual significance threshold, sums up to a significant signal for that specific source type.

In this analysis, the same data set as in Adrián-Martínez et al. (2011) is used, and the possibility that a class of sources that might emit UHECRs also emit neutrinos is tested. Only the cumulative result for a class of sources is evaluated, not the signal from individual sources.

The ANTARES Collaboration follows a strict blindness policy, i.e., an analysis has to be developed blindly with respect to the data. This prevents statistical fluctuations from affecting the final steps of the analysis and means that no signal is evaluated until the source samples and all analysis parameters are fixed.

3. MAGNETIC DEFLECTION OF UHECRs

In this paper, the directions of candidate neutrino events observed by the ANTARES telescope were analyzed for correlations with UHECR events recorded by the Pierre Auger Observatory, using a source stacking method in which the cumulative neutrino signal from all UHECR directions is

summed and compared with the expected background. A key parameter for this analysis is the size of the angular search bin around each UHECR direction. The size of this bin is derived from the assumed magnetic deflection of the UHECRs.

The magnitude of magnetic deflection in Galactic and intergalactic magnetic fields is unknown. There are no observational data constraining intercluster magnetic fields, and also, some features of the Galactic magnetic field, such as possible magnetized halo are not yet known. Theoretical predictions of UHECR deflection in both Galactic and intergalactic magnetic fields give various estimates that vary from one to a few tens of degrees, depending on different assumptions.

Protons with the highest energies (above 10^{19} eV) are expected to be deflected by the Galactic magnetic field up to a few degrees (Stanev 1997; Alvarez-Muñiz et al. 2002; Takami & Sato 2010). Medina Tanco et al. (1998) calculated that protons with energies of 4×10^{19} eV should be deflected by about 5° . Harari et al. (1999) concluded that 10^{20} eV protons arrive to Earth almost undeflected. Deflection angles of about 3° , for protons of 4×10^{19} eV, were estimated by Prouza & Smida (2003). Since there are no observational data constraining extragalactic magnetic fields, proton deflection in those fields is not known. Simulations by different authors obtained values for an expected proton deflection from a couple to a few tens of degrees (Dolag et al. 2005; Kotera & Lemoine 2008; Sigl et al. 2004, 2003; Armengaud et al. 2005).

If the composition of UHECRs is mostly heavy, an identification of their sources would likely be impossible, as their expected deflection would then be tens of degrees, and their arrival directions are expected to be isotropically distributed. Medina Tanco et al. (1998) found that Fe nuclei with energies of 2.5×10^{20} eV can be deflected up to 20° in the Galactic magnetic field. Prouza & Smida (2003) also calculated deflection angles of a few tens of degrees for heavy UHECRs. This was also confirmed in a recent paper by Takami & Sato (2010).

However, as it was mentioned earlier, this analysis considers the scenario where most observed UHECRs are protons. The choice of magnetic deflection angle presented in this paper is based on the lower estimates for proton deflection angles, and is further justified by the fact that using larger search bins destroys the benefits of stacking analysis (see Section 6).

4. NEUTRINO AND UHECR DATA SAMPLES

The ANTARES neutrino telescope (Ageron et al. 2011) is located in the Mediterranean Sea, 40 km off the southern coast of France ($42^\circ 48' N$, $6^\circ 10' E$), at a depth of 2475 m. It was completed in 2008 and its final configuration is a three-dimensional array of photomultipliers in glass spheres (optical modules; Amram et al. 2002), distributed along 12 lines anchored to the sea bottom and kept taut by a buoy at their top. Of these detection lines, 11 contain 25 storeys of triplets of optical modules and one contains 20 triplets. The lines are subject to sea currents and can change shape and orientation. A positioning system based on hydrophones, compasses and tiltmeters is used to monitor the detector geometry with an accuracy of 10 cm. The total instrumented volume of the ANTARES telescope is about 10^7 m³. The detection principle is based on measuring the Cherenkov light emitted in the detector by high energy muons, that result from neutrino interactions inside or near the instrumented volume of the detector. The large background from downgoing muons produced in cosmic ray air showers is reduced by selecting only upgoing muons as neutrino candidates.

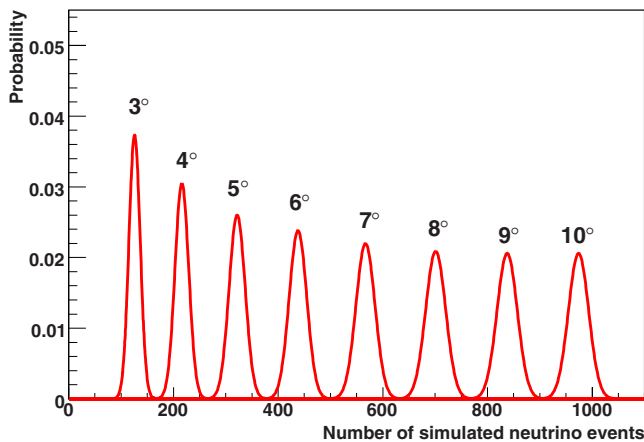

Figure 1. The probability density functions of the number of neutrino events in 3° – 10° bins centered on 69 UHECR directions. The corresponding Gaussian mean values (standard deviations) for bins of 3° – 10° are 125.8(10.7), 216.1(13.3), 321.3(15.6), 437.4(17.1), 566.6(18.0), 700.8(19.1), 838.0(19.1) and 974.3(19.0), respectively.

(A color version of this figure is available in the online journal.)

The data acquisition system of the detector (Aguilar et al. 2007) is based on the “all-data-to-shore” concept, in which signals from the photomultipliers above a given threshold are digitized and sent to shore for processing. The absolute time is provided by GPS and the precise timing resolution for the recorded photo-multiplier tube signals (of the order of 1 ns) is required to maintain the angular resolution of the telescope. The arrival times of the hits are calibrated as described in Aguilar et al. (2011a). A L1 hit is defined either as a high-charge hit, or as hits separated by less than 20 ns in optical modules of the same storey. At least five L1 hits are required throughout the detector within a time window of $2.2 \mu\text{s}$, with the relative photon arrival times being compatible with the light coming from a relativistic particle. Independently, events which have L1 hits on two sets of adjacent or next-to-adjacent floors are also selected. The physics events are stored on disk for offline reconstruction.

The data used in this analysis were collected between 2007 January 31, and 2008 December 30. During this time the construction of the detector was still in progress. The detector consisted of 5 lines for most of 2007 and of 9, 10 and 12 lines during 2008. For part of that period, the data acquisition was interrupted for the connection of new lines, and in addition, some periods were excluded due to a high bioluminescence-induced optical background. The resulting effective live time of the analysis is 304 days.

Triggered events were reconstructed offline to determine the muon trajectory using a multi-stage fitting procedure. The final stage of this procedure consists of a maximum likelihood fit of the measured photon arrival times. A quality parameter, indicated by λ , is determined based on the final value of the likelihood function. Selection cut on parameter $\lambda > -5.4$ has been optimized in order to obtain the best point source sensitivity (Adrián-Martínez et al. 2011). The estimated angular uncertainty obtained from the muon track fit is required to be smaller than 1° . The final data sample consists of 2190 ongoing neutrino candidate events. For this current analysis, no selection was done based on the energy reconstruction. The angular resolution was estimated to be 0.5 ± 0.1 . The simulations indicate that the selected sample contains 60% atmospheric neutrinos, the rest are misreconstructed atmospheric muons.

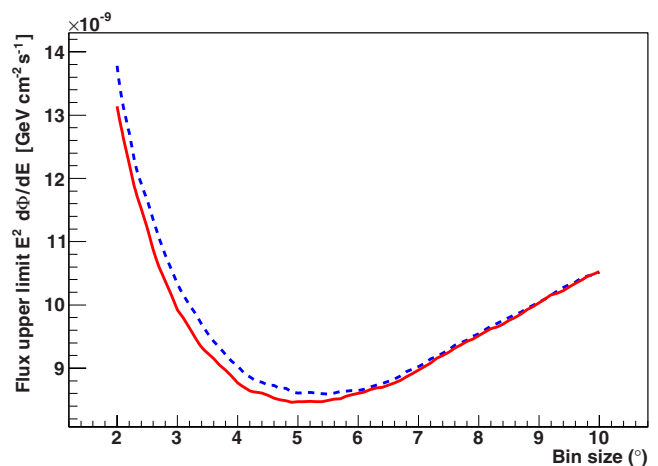

Figure 2. The mean flux upper limit (90% CL) as a function of the search bin size and for a magnetic deflection of 3° is presented with the red solid line. The mean upper limit for an angular resolution degraded by a factor two is shown with the blue dashed line.

(A color version of this figure is available in the online journal.)

Previously, the Pierre Auger Observatory reported an anisotropy in the arrival directions of UHECRs (Abraham et al. 2008b) and indicated a correlation with AGNs from the Veron-Cetty & Veron (VCV) catalog (Véron-Cetty & Véron 2006). After a scan of the relevant parameters, the prescription was made on a subsample of data and the correlation was found to be the most significant for a sample of 27 events corresponding to cosmic ray energies higher than 57 EeV, falling within a bin of size $3^\circ:1$ around the AGNs from the VCV catalog, located at distances smaller than 75 Mpc. However, the HiRes Collaboration reported an absence of a comparable correlation in observations in the Northern hemisphere (Abbasi et al. 2008b). Further, the suggested correlation of the Pierre Auger UHECRs with the nearby AGN sources decreased in a subsequent analysis (Abreu et al. 2010) with 69 events at energies above 55 EeV ($10^{19.74}$ eV), observed until 2009 December 31. These 69 UHECR events were used in the correlation analysis presented in this paper. The angular resolution for these events is better than 1° .

5. BACKGROUND AND SIGNAL SIMULATIONS

In order to study the statistical significance of any observed correlation between the neutrino and UHECR datasets and determine an optimal angular search bin, an MC set with 10^6 pseudo-experiments is generated, each with 2190 neutrinos and 69 UHECRs. In each of these pseudo-experiments the positions of UHECRs are fixed according to the Pierre Auger Observatory dataset and the neutrino background is randomly generated by scrambling the 2190 neutrinos from the ANTARES telescope dataset in right ascension. The number of neutrinos within an angular bin of chosen size, centered on 69 UHECR events, is counted. The normalized probability density function is calculated and fitted with a Gaussian distribution, to obtain the mean neutrino count and its standard deviation expected from the randomized background samples. This procedure is repeated for a range of different bin sizes.

For illustration, Figure 1 shows an example count of neutrinos for bins of 3° – 10° size. The count of events is done by summing neutrinos in all 69 bins for which the minimum angular distance to UHECRs is smaller than the bin size. In this way, when

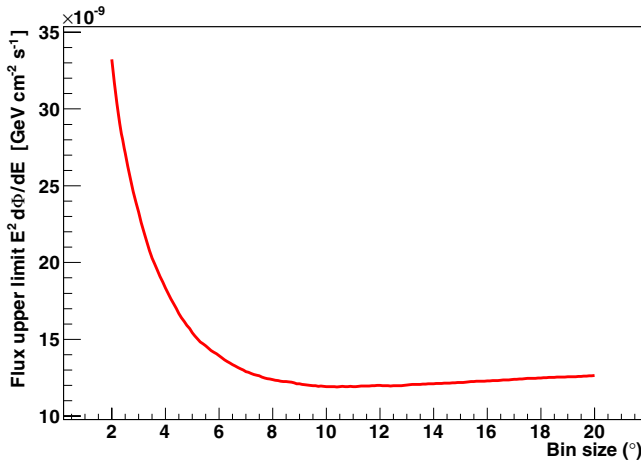

Figure 3. The mean flux upper limit (90% CL) as a function of the search bin size and for a magnetic deflection of 6° .

(A color version of this figure is available in the online journal.)

the same neutrino event falls within multiple bins around the UHECRs, a double counting of neutrino events is avoided. After optimizing an angular bin size (as described in Section 6), the significance of the observed number of neutrino events within 69 bins is calculated by comparison with the distribution for the pure background MC sample.

The signal events are simulated assuming a neutrino energy spectrum proportional to E^{-2} and equal flux strength from each of 69 UHECR directions. Flux values from $0.5 \times 10^{-8} \text{ GeV cm}^{-2} \text{ s}^{-1}$ to $10^{-7} \text{ GeV cm}^{-2} \text{ s}^{-1}$ are considered. The flux is converted into signal event rate per source using the effective area for 5–12 lines and the corresponding live time. For every source, signal neutrinos are generated according to the Poisson distribution with the event rate per source as mean value. For example, a flux value of $10^{-8} \text{ GeV cm}^{-2} \text{ s}^{-1}$ gives 0.85 signal neutrinos per UHECR source, or about 58 events for all stacked sources. Signal neutrinos are randomly generated according to a Gaussian which is a result of a convolution of the magnetic field deflection window of 3° and the angular resolution of the ANTARES telescope. The same amount of background neutrinos is removed from a declination band of 10° centered on each UHECR to ensure that every random sky has 2190 events and to keep the neutrino declination distribution profile close to the observed profile.

6. ANGULAR SEARCH BIN OPTIMIZATION

MC predictions are used to obtain an optimal angular search bin size. This is done by the minimization of the mean flux upper limit or so-called Feldman–Cousins sensitivity (Feldman & Cousins 1998; Hill & Rawlins 2003) that would be observed over the set of identical experiments with expected background n_b and no true signal.

In such a case, the background n_b fluctuates to different values with different Poisson probabilities, each one associated with an upper limit or the 90% Feldman–Cousins confidence interval μ_{90} that is a function of the number of observed events, n_{obs} , and of the expected background n_b . Note that this can be done for any level of confidence or any formulation of confidence intervals.

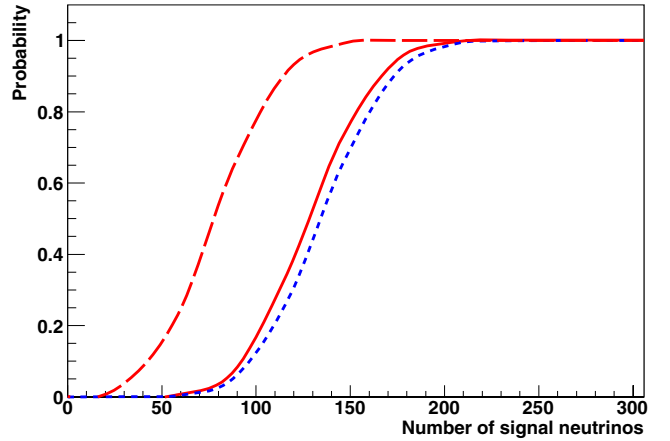

Figure 4. The discovery potential at 3σ (red long-dashed line) and 5σ (red solid line) 90% CL as a function of the number of neutrino signal events from 69 sources on the whole sky. The discovery potential for an angular resolution degraded by a factor two is shown with the blue dashed line.

(A color version of this figure is available in the online journal.)

The mean upper limit is the sum of these expected upper limits, weighted by their Poisson probability of occurrence:

$$\overline{\mu}^{90}(n_b) = \sum_{n_{\text{obs}}=0}^{\infty} \mu^{90}(n_{\text{obs}}, n_b) \binom{n_b}{n_{\text{obs}}} e^{-n_b}. \quad (1)$$

Over an ensemble of identical experiments, the strongest constraint on the expected signal flux corresponds to a set of cuts that minimizes the model rejection factor μ_{90}/n_s and at the same time minimizes the mean flux upper limit that would be obtained over the hypothetical experimental ensemble:

$$\overline{\Phi}(E, \theta)_{90} = \Phi(E, \theta)(\mu_{90}/n_s), \quad (2)$$

where $\Phi(E, \theta)$ is the theoretical flux that is proportional to the number of signal events n_{sig} . From the equation above, it can be seen that the mean flux upper limit, and as a result also the optimized angular bin size, does not depend on a modeled signal strength.

The described Feldman–Cousins’s approach with the Rolke extension (Rolke et al. 2005) was used to calculate the 90% upper limit on the neutrino flux per source assuming an E^{-2} energy spectrum, as a function of the search bin size.

An E^{-2} energy spectrum was assumed to maintain compatibility with the previously published ANTARES point source search and diffuse limit analysis (Adrián-Martínez et al. 2011, 2012; Aguilar et al. 2011b). This choice was also further discussed and motivated in Aguilar et al. (2011b). The MC simulations showed that 80% of the signal from neutrino-induced muons, assuming an E^{-2} energy spectrum, will lie in the energy range from 4 to 700 TeV. In theoretical predictions, neutrino spectra of E^{-2} or harder are expected (see, e.g., Mannheim 1995; Mannheim et al. 2001; Stecker 2005; Semikoz & Sigl 2004).

Using 3° magnetic deflection window, the angular search bin that minimizes the flux upper limit is $4^\circ 9$ (Figure 2). If an assumed magnetic deflection is represented with a Gaussian with a 6° width, the optimized angular search bin is $10^\circ 4$ (Figure 3). Such a large search bin placed around 69 observed UHECRs covers a significant part of the visible sky, destroying the benefit of a stacking analysis. Because of this and in order to avoid the

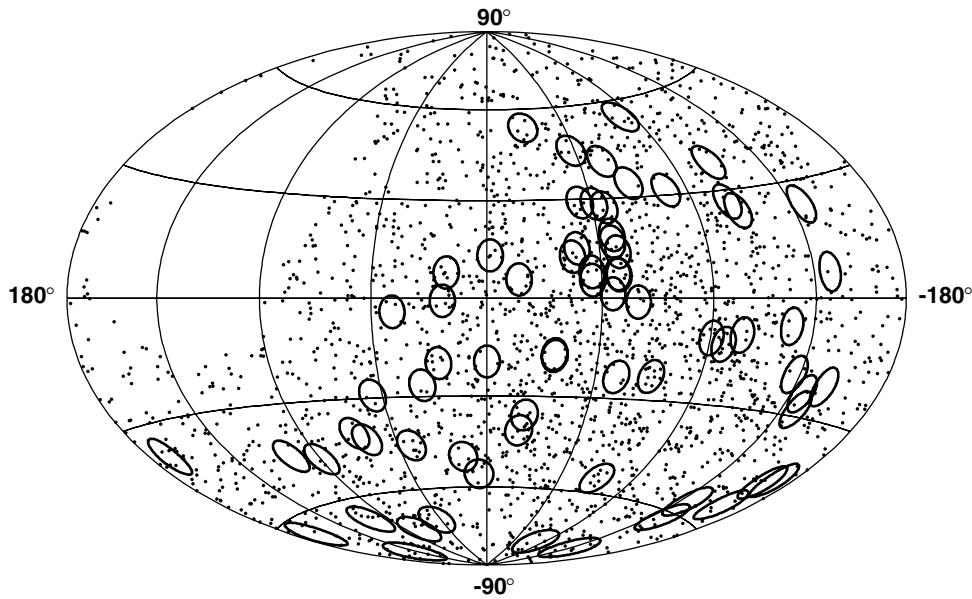

Figure 5. On this sky map in Galactic coordinates, neutrino events are represented with black dots and angular search bins of $4^\circ.9$ centered on the observed UHECRs with black circles.

trial factor associated with using multiple tolerance windows for the magnetic deflection, a single value of 3° Gaussian width is adopted for this analysis.

7. DISCOVERY POTENTIAL

With the angular search bin size optimized and fixed, it is possible to estimate the probability of making a 3σ or a 5σ 90% CL discovery given a certain signal flux. First, the neutrino count necessary for a chosen σ level is determined from the background MC samples. Then, the number of pseudo-experiments with signal, that have more neutrinos in 69 optimized bins than the chosen σ level from background only, is counted and this gives a direct measure of the discovery potential for that particular flux. Figure 4 shows the discovery potential for 5σ (red solid line) and 3σ (red long-dashed line) discovery, for an optimized bin size of $4^\circ.9$. Around 125 (75) signal events correlated to the 69 UHECRs directions are needed for a 5σ (3σ) discovery in 50% of trials. This counts correspond to a flux per source of $2.16 \times 10^{-8} \text{ GeV cm}^{-2} \text{ s}^{-1}$ and $1.29 \times 10^{-8} \text{ GeV cm}^{-2} \text{ s}^{-1}$ or the event count per source of 1.8 and 1.1, respectively.

To quantify the improvement of sensitivity of a source stacking approach, those numbers can be compared to the single source search. To claim a 5σ discovery (50% discovery potential), for a localized excess, depending on a declination, 6–10 signal events are needed (Adrián-Martínez et al. 2011, 2012).

To check the effect of the possible angular resolution systematic uncertainty on the sensitivity and discovery potential, MC simulations with an angular resolution degraded by a factor two were performed. The optimized bin value in this case is $5^\circ.5$, compared with $4^\circ.9$ obtained from the observed angular resolution. This degraded angular resolution results in about a 20% higher neutrino flux upper limit. No significant effect is found on the discovery potential. Figures 2 and 4 show, respectively, optimized bin and discovery potential for observed and two times lower angular resolution. Note that the expected error on the angular resolution, as we already mentioned, is estimated to be much smaller ($0^\circ.1$).

8. RESULTS

To analyze the level of correlation between the distribution of 2190 neutrino candidates observed by the ANTARES telescope and 69 UHECRs reported by the Pierre Auger Observatory, the right ascension of the neutrino candidate events was unblinded. The significance of an observed correlation is determined with the help of randomized background samples, using the optimized bin of $4^\circ.9$. The most probable count for this optimized bin size, or the mean background expectation from the randomized samples, is 310.5 events (in all 69 bins), with a standard deviation of 15.2 events. After unblinding the 2190 ANTARES telescope neutrino candidate events, a count of 290 events within 69 bins is obtained (Figure 5), which is slightly lower than expected. This count is compatible with an underfluctuation of the background, with a significance of 1.4σ . The corresponding 90% CL upper limit on the neutrino flux from each observed UHECR direction (assuming an equal flux from all of them and for an E^{-2} energy spectrum) is $5.0 \times 10^{-8} \text{ GeV cm}^{-2} \text{ s}^{-1}$.

None of the 69 angular search bins centered on the observed UHECRs show an individual excess of neutrinos. Individual counts with the largest significances are in the search bins around the observed UHECR with declination of $44^\circ.2$ and right ascension $224^\circ.5$ (10 events), and with declination of $-50^\circ.6$, and right ascension of 116° (11 events).

The lack of correlation of neutrinos observed by the ANTARES telescope and the UHECRs observed by the Pierre Auger Observatory can be due to various reasons. As already discussed in detail, the magnitude of magnetic deflection that influences the path of UHECRs is not known. Also, UHECRs are only originating from sources within the GZK sphere, while this is not the case with neutrinos. Also, as explained, even if hadronic acceleration is taking place in astrophysical sources, depending on the opacity for protons, they can be emitting both neutrinos and protons, or only neutrinos or protons.

In the future, the increased statistics available from both experiments will allow us to select only the highest energy events thereby reducing the uncertainties related to magnetic deflection.

The authors acknowledge comments and suggestions of members of the Pierre Auger Collaboration. The authors acknowledge the financial support of the funding agencies: Centre National de la Recherche Scientifique (CNRS), Commissariat à l'énergie atomique et aux énergies alternatives (CEA), Agence National de la Recherche (ANR), Commission Européenne (FEDER fund and Marie Curie Program), Région Alsace (contract CPER), Région Provence-Alpes-Côte d'Azur, Département du Var and Ville de La Seyne-sur-Mer, France; Bundesministerium für Bildung und Forschung (BMBF), Germany; Istituto Nazionale di Fisica Nucleare (INFN), Italy; Stichting voor Fundamenteel Onderzoek der Materie (FOM), Nederlandse organisatie voor Wetenschappelijk Onderzoek (NWO), The Netherlands; Council of the President of the Russian Federation for young scientists and leading scientific schools supporting grants, Russia; National Authority for Scientific Research (ANCS-UEFISCDI), Romania; Ministerio de Ciencia e Innovación (MICINN), Prometeo of Generalitat Valenciana and MultiDark, Spain. We also acknowledge the technical support of Ifremer, AIM and Foselev Marine for the sea operation and the CC-IN2P3 for the computing facilities.

REFERENCES

- Abbasi, R., Abdou, Y., Abu-Zayyad, T., et al. 2011, *ApJ*, **732**, 18
 Abbasi, R., Abdou, Y., Ackermann, M., et al. 2009a, *ApJL*, **701**, L47
 Abbasi, R. U., Abu-Zayyad, T., Al-Seady, M., et al. 2009b, *Aph*, **32**, 53
 Abbasi, R. U., Abu-Zayyad, T., Allen, M., et al. 2008a, *PhRvL*, **100**, 101101
 Abbasi, R. U., Abu-Zayyad, T., Allen, M., et al. 2008b, *Aph*, **30**, 175
 Abraham, J., Abreu, P., Aglietta, M., et al. 2008a, *PhRvL*, **101**, 061101
 Abraham, J., Abreu, P., Aglietta, M., et al. 2008b, *Aph*, **29**, 188
 Abraham, J., Abreu, P., Aglietta, M., et al. 2010, *PhLB*, **685**, 239
 Abreu, P., Aglietta, M., Ahn, E. J., et al. 2010, *Aph*, **34**, 314
 Achterberg, A., Ackermann, M., Adams, J., et al. 2006, *Aph*, **26**, 282
 Adrián-Martínez, S., Aguilar, J. A., Al Samarai, I., et al. 2011, *ApJL*, **743**, L14
 Adrián-Martínez, S., Al Samarai, I., Albert, A., et al. 2012, *ApJ*, **760**, 53
 Ageron, M., Aguilar, J. A., Al Samarai, I., et al. 2011, *NIMPA*, **656**, 11
 Aguilar, J. A., Al Samarai, I., Albert, A., et al. 2011a, *Aph*, **34**, 539
 Aguilar, J. A., Al Samarai, I., Albert, A., et al. 2011b, *PhLB*, **696**, 16
 Aguilar, J. A., Albert, A., Ameli, F., et al. 2007, *NIMPA*, **570**, 107
 Alvarez-Muñiz, J., Engel, R., & Stanev, T. 2002, *ApJ*, **572**, 185
 Amram, P., Anghinolfi, M., Anvar, S., et al. 2002, *NIMPA*, **484**, 369
 Armengaud, E., Sigl, G., & Miniati, F. 2005, *PhRvD*, **72**, 043009
 Avrorin, A. V., Aynutdinov, V. M., Balkanov, V. A., et al. 2009, *AstL*, **35**, 651
 Bahcall, J., & Waxman, E. 2001, *PhRvD*, **64**, 023002
 Becker, J. K. 2008, *PhR*, **458**, 173
 Becker, J. K., & Biermann, P. L. 2009, *Aph*, **31**, 138
 Biermann, P. L., & Strittmatter, P. A. 1987, *ApJ*, **322**, 643
 Dolag, K., Grasso, D., Springel, V., & Tkachev, I. 2005, *JCAP*, **01**, 009
 Feldman, G. J., & Cousins, R. D. 1998, *PhRvD*, **57**, 3873
 Greisen, K. 1966, *PhRvL*, **16**, 748
 Harari, D., Mollerach, S., & Roulet, E. 1999, *JHEP*, **08**, 022
 Hill, G. C., & Rawlins, K. 2003, *Aph*, **19**, 393
 Kang, H., & Jones, T. W. 2005, *ApJ*, **620**, 44
 Kang, H., Rachen, J. P., & Biermann, P. L. 1997, *MNRAS*, **286**, 257
 Kang, H., Ryu, D., & Jones, T. W. 1996, *ApJ*, **456**, 422
 Kotera, K., & Lemoine, M. 2008, *PhRvD*, **77**, 123003
 Ma, R., Ryu, D., & Kang, H. 2011, *JApA*, **32**, 301
 Mannheim, K. 1995, *Aph*, **3**, 295
 Mannheim, K., Protheroe, R. J., & Rachen, J. P. 2001, *PhRvD*, **63**, 023003
 Medina Tanco, G. A., de Gouveia dal Pino, E. M., & Horvath, J. E. 1998, *ApJ*, **492**, 200
 Murase, K., Ioka, K., Nagataki, S., & Nakamura, T. 2006, *ApJL*, **651**, L5
 Nellen, L., Mannheim, K., & Biermann, P. L. 1993, *PhRvD*, **47**, 5270
 Prouza, M., & Smida, R. 2003, *A&A*, **410**, 1
 Rachen, J. P. 2008, Proc. XXth Rencontres de Blois, arXiv:0808.0349
 Rachen, J. P., & Biermann, P. L. 1993, *A&A*, **272**, 161
 Rachen, J. P., Protheroe, R. J., & Mannheim, K. 2000, *NuPhS*, **80**, C812
 Rolke, W. A., López, A. M., & Conrad, J. 2005, *NIMPA*, **551**, 493
 Semikoz, D. V., & Sigl, G. 2004, *JCAP*, **04**, 003
 Sigl, G., Miniati, F., & Ensslin, T. A. 2003, *PhRvD*, **68**, 043002
 Sigl, G., Miniati, F., & Enßlin, T. A. 2004, *PhRvD*, **70**, 043007
 Stanev, T. 1997, *ApJ*, **479**, 290
 Stecker, F. W. 2005, *PhRvD*, **72**, 107301
 Stecker, F. W., Done, C., Salamon, M. H., & Sommers, P. 1991, *PhRvL*, **66**, 2697
 Takami, H., & Sato, K. 2010, *ApJ*, **724**, 1456
 Véron-Cetty, M.-P., & Véron, P. 2006, *A&A*, **455**, 773
 Vietri, M. 1995, *ApJ*, **453**, 883
 Waxman, E. 1995, *PhRvL*, **75**, 386
 Waxman, E., & Bahcall, J. 1997, *PhRvL*, **78**, 2292
 Waxman, E., & Bahcall, J. 1999, *PhRvD*, **59**, 023002
 Zatsepin, Z., & Kuzmin, V. 1966, *ZhPmR*, **4**, 144